



## High Current Power Switch

### FEATURES

- Max  $R_{DS(ON)}$  .377 Ohms
- Overcurrent deactivation 800mA
- Max leakage current less than  $2\mu A$  while deactivated
- Small 6 pin SOT-23 package
- Built-in Over-temperature Protection
- 4.5V to 5.5V input voltage range

### APPLICATIONS

- Ultra low cost handsets
- PDA, DSC, MP3 players
- Cell phones
- Power Distribution Switch
- Battery-Charger Circuit

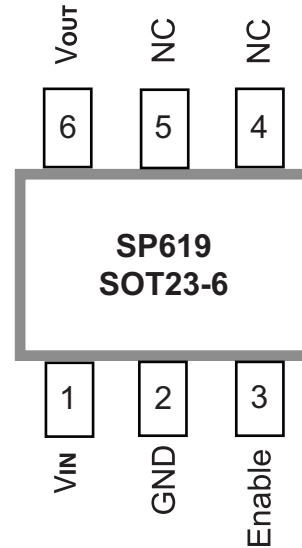

### DESCRIPTION

The SP619 is a low  $R_{DS(ON)}$  high current switch designed with precision current limiting to protect connected devices from damage due to a short circuit condition or against current surges that may cause the supply voltages to fall out of regulation. This switch is functional over an input voltage range of 2.5V to 7V, but is targeted at 5V applications. The SP619 is also protected from thermal overload which limits power dissipation. In shutdown mode, the supply current drops to  $2\mu A$ .

### TYPICAL APPLICATION CIRCUIT

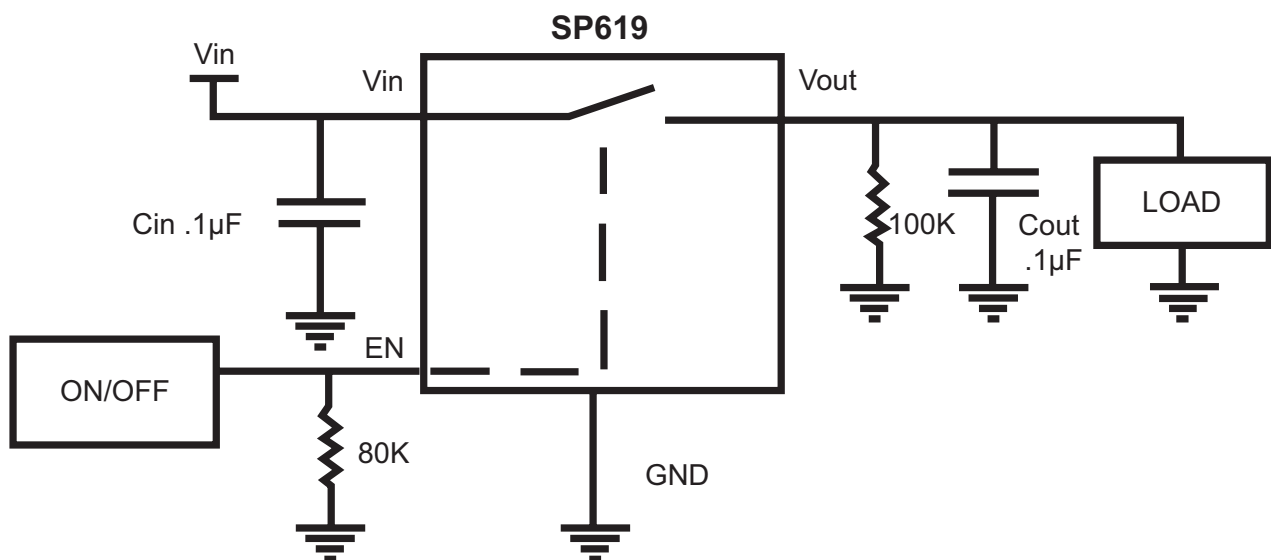

## ABSOLUTE MAXIMUM RATINGS

These are stress ratings only and functional operation of the device at these ratings or any other above those indicated in the operation sections of the specifications below is not implied. Exposure to absolute maximum rating conditions for extended periods of time may affect reliability.

V <sub>IN</sub> .....	-0.3V to 7V
Storage Temperature.....	-65°C to 150°C
Junction Temperature.....	150°C
Lead Temperature (Soldering, 10 sec).....	300°C
ESD RATING	
Human Body Model.....	2000V
Machine Model.....	200V
OPERATING RATINGS	
Thermal resistance SOT23-6	
Junction to Ambient.....	191°C
Junction to lead .....	50°C

## RECOMMENDED OPERATING CONDITIONS

Unless otherwise specified: V<sub>IN</sub> = 4.5V - 5.5V, C<sub>IN</sub> = 0.1μF, T<sub>A</sub> = -10°C to + 85°C

PARAMETER	CONDITIONS	MIN	TYP (Note 1)	MAX	UNITS
Operating Input Voltage Range		4.5		5.5	V
Overcurrent Deactivation Range	EN=1.5V	620	800	1010	mA
Overcurrent Duration Before Deactivation	EN=1.5V	1		5.25	ms
Shutdown Supply Current	V <sub>IN</sub> =4.5V			2	μA
Quiescent Supply Current	EN=1.5V V <sub>IN</sub> =4.5V I <sub>OUT</sub> =0mA			350	μA
Quiescent Supply Current	EN=1.5V V <sub>IN</sub> =4.5V I <sub>OUT</sub> =725mA			5.25	mA
R <sub>DS(ON)</sub>	V <sub>IN</sub> =4.5V I <sub>OUT</sub> =100mA EN=1.5V			.377	Ω
Post Fault Output Load for Recovery	Enable=1.5V	10	15	23	KΩ
Post Fault Activation Turn On Time	Enable=1.5V	1		55	ms
Thermal Shutdown Die Temperature	SP619 will self recover when temperature drops below the trip point .	120	150	180	°C
Thermal Restart Die Temperature		90	120	135	°C
ENABLE Logic LOW	Driver is disabled			.5	V
ENABLE Pin Logic HIGH	Driver is active	.655		1.4	V
Turn On Delay	R <sub>L</sub> =100kΩ, C <sub>L</sub> = 0.01μF (Note 2,3)			600	μs
Turn Off Delay	R <sub>L</sub> =100kΩ, C <sub>L</sub> = 0.01μF (Note 2,4)			200	μs
Rise Time	R <sub>L</sub> =100kΩ, C <sub>L</sub> = 0.01μF (Note 2)			100	μs
Fall Time	R <sub>L</sub> =100kΩ, C <sub>L</sub> = 0.01μF (Note 2)			2500	μs

Note 1: Typicals are T<sub>J</sub>=25°C

Note 2: Characterized, not 100% tested

Note 3: Turn on delay is measured from the time the enable pin is turned on to the time it takes the output to rise to 10% of its final value.

Note 4: Turn off delay is measured from the time the enable pin is turned to the time it takes for the output to fall to 90% of its current value.

**FAULT AND RECOVERY TRUTH TABLE\***

Enable	Load	Temperature (T <sub>J</sub> )	Previous State	Switch	Current State/Fault (Note*)
Low	X	X	X	Open	Off
High	< 800 mA	< 163°C	Off	Closed	Normal
High	< 800 mA	> 163°C	Off	Open	Thermal Cutoff
High	> 800 mA	< 163°C	Off	Open	Overcurrent
High	> 800 mA	> 163°C	Off	Open	Thermal Cutoff, Overcurrent
High	< 15kΩ	< 163°C	Overcurrent	Open	Load Condition
High	< 15kΩ	> 163°C	Overcurrent	Open	Thermal Cutoff, Overcurrent, Load Condition
High	> 15kΩ	< 163°C	Overcurrent	Closed	Normal
High	> 15kΩ	> 163°C	Overcurrent	Open	Thermal Cutoff
High	< 15kΩ	< 120°C	Thermal Cutoff	Open	Load Condition
High	< 15kΩ	> 120°C	Thermal Cutoff	Open	Load Condition, Thermal Cutoff
High	> 15kΩ	< 120°C	Thermal Cutoff	Closed	Normal
High	> 15kΩ	> 120°C	Thermal Cutoff	Open	Thermal Cutoff

\*Note: This table is for fault conditions, not for continuous operation, else damage to the device may occur. In order to recover to the normal state after a Thermal Cutoff fault, the part's junction temperature must decrease below 120°C and the load on its output must be greater than 15kΩ.

**PIN ASSIGNMENTS**

PIN NUMBER	PIN NAME	FUNCTION
1	V <sub>IN</sub>	Input power supply pin (4.5V to 5.5V)
2	GND	Ground connection
3	Enable	A logic high turns on the switch
4	NC	No connect
5	NC	No connect
6	V <sub>OUT</sub>	Switch output

The SP619 is a switch capable of handling up to 800mA of current.

The SP619 is targeted as a for 5V USB protection power distribution switch. And can be used in general power distribution applications where short circuits are likely to be encountered.

**Short circuit operation**

When the SP619 enters a short circuit condition, the switch is disabled. The output of the SP619 will not restart until the output impedance is greater than 15KΩ. The enable pin can be used to re-enable the SP619 into any load condition that is not a fault condition. Refer to the truth table on page 4 for more information on the different SP619 switch states. The typical deactivation time is about 2ms.

**Enable**

The enable pin allows easy control of the SP619. The enable pin should not be enabled high prior to a voltage being present on the input of the device. The enable pin should not exceed the input voltage by more than 0.1V due to an internal ESD diode. Doing so will affect the operation of the SP619 and could damage the device. In a typical application an 80KΩ resistor to GND should be used on the enable pin. This resistor will pull the enable low when an enable signal is not present. This prevents the SP619 from falsely turning on. The enable pin can also be used to restart the part into a load condition that is high in current. Please refer to the truth table on page 4 for more details.

**Inrush Current**

The SP619 is a simple resistive switch. When the switch is turned on into a highly capacitive load there could be a significant

inrush current that can be encountered. At 6 volts in, the inrush current was about 250mA into a 100µF capacitor.

**Output Voltage Rise Time**

The output voltage of the SP619 has an output capacitance dependency on the slope of V<sub>OUT</sub>. A simple RC circuit is created when the switch is turned on.

Equation 1

$$V(t) = V_0 + V_{IN} \left( 1 - e^{-\frac{t}{R_{DS(ON)} \cdot C_{OUT}}} \right)$$

Where V<sub>0</sub> is initial Voltage condition typically 0V

V<sub>IN</sub> is the input voltage

R<sub>DS(ON)</sub> is the switch resistance

C<sub>OUT</sub> is the output capacitance

For 4.2V V<sub>IN</sub> and 100µF output capacitance we get about 150ns delay in figure 2.

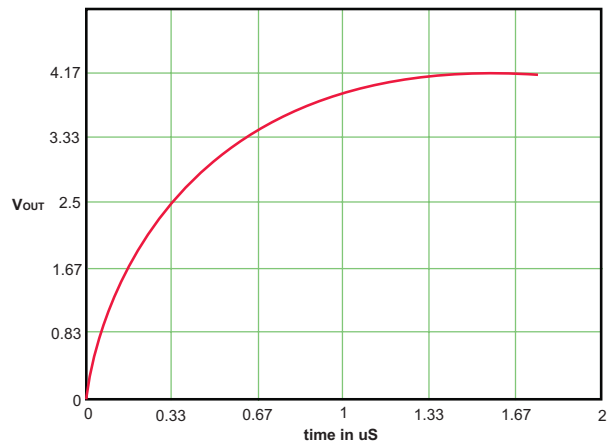

This is comparable to actual measured value in figure 3.

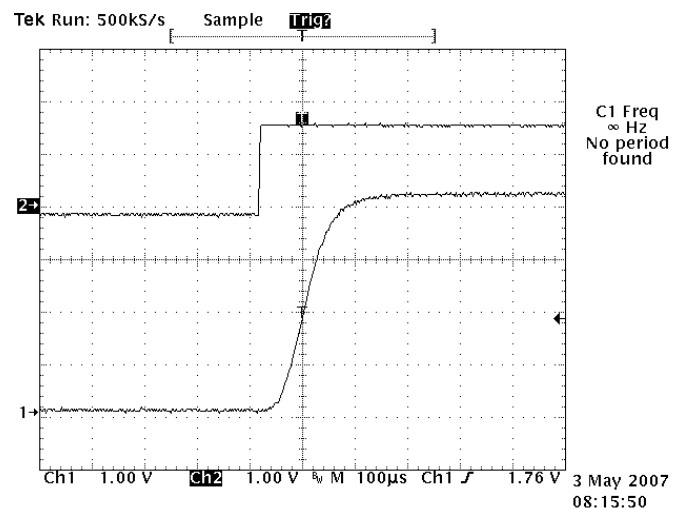

### Overtemperature Protection

The SP619 has built-in overtemperature protection to protect the part against damage if the die temperature gets too hot. The typical thermal cutoff is about 150°C. The part will self recover if the temperature drops below the thermal restart threshold of about 120°C.

### Layout Considerations

The input and output decoupling capacitors should be placed as close as possible to the input and output pins. The GND pin should be stitched to the GND plain to help with thermal performance. The input and output traces should be as large as possible. The 100K $\Omega$  is also recommended in the design and should be placed close to the output decoupling cap.

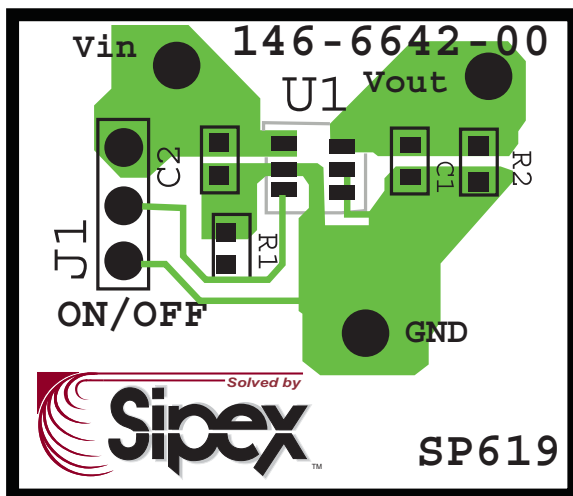

Recommended Layout

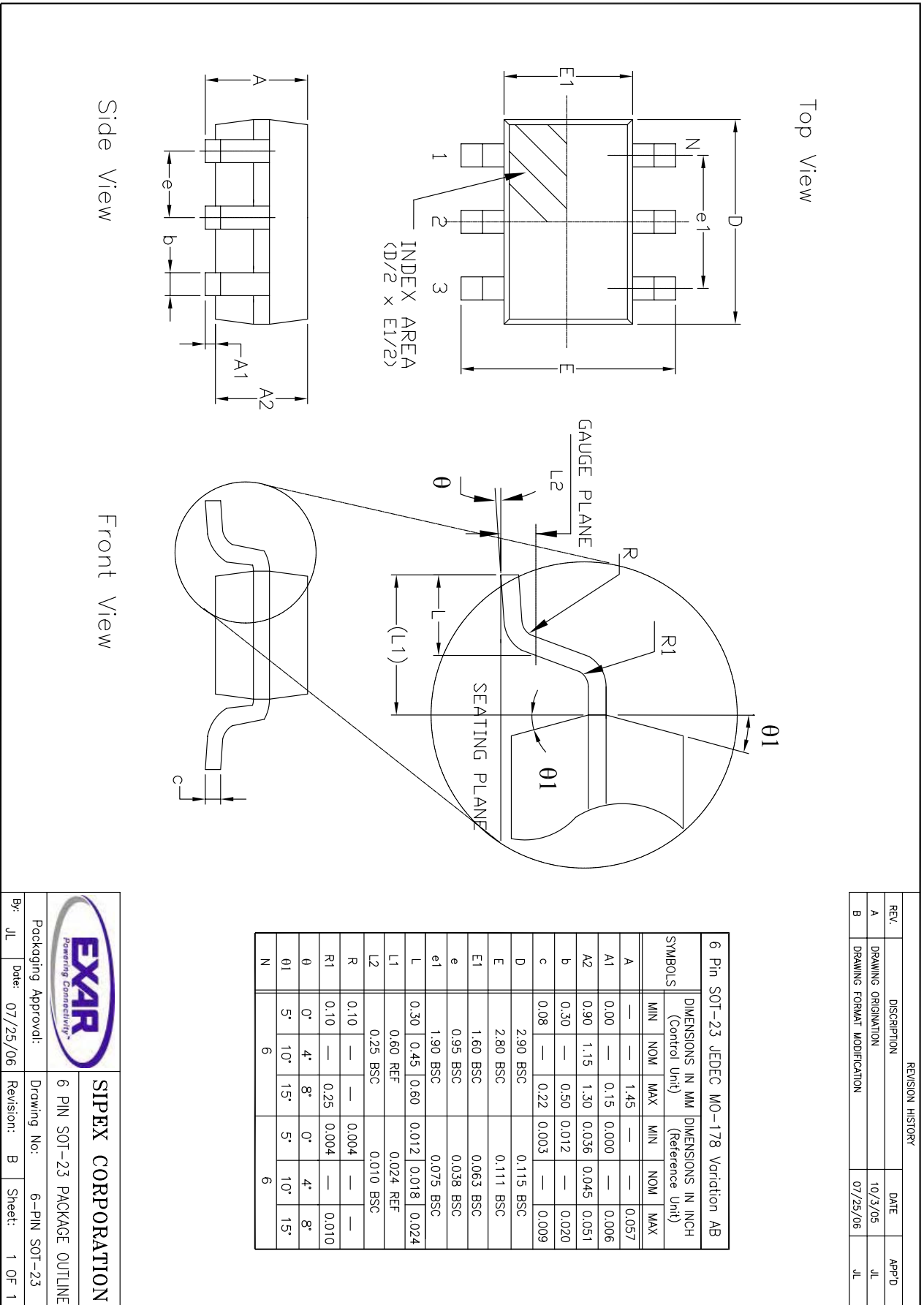

REVISION HISTORY			
REV.	DESCRIPTION	DATE	APP'D
A	DRAWING ORIGINATION	10/3/05	JL
B	DRAWING FORMAT MODIFICATION	07/25/06	JL

**EXAR**  
 Powering Connectivity™

**SIPLEX CORPORATION**  
 6 PIN SOT-23 PACKAGE OUTLINE

Packaging Approval: \_\_\_\_\_  
 Drawing No: 6-PIN SOT-23  
 By: JL Date: 07/25/06 Revision: B Sheet: 1 OF 1

---

**ORDERING INFORMATION**

Part number	Temperature range	Package Type
SP619EK-L	From -10 to +85°C	Lead Free 6 pin SOT23
SP619EK-L/TR	From -10 to +85°C	Lead Free 6 pin SOT23

/TR = Tape and Reel.

For further assistance:

Email: [customersupport@exar.com](mailto:customersupport@exar.com)

EXAR Technical Documentation: <http://www.exar.com/TechDoc/default.aspx?>

Exar Corporation Headquarters and Sales Office

48720 Kato Road

Fremont, CA 94538

main: 510-668-7000

fax: 510-668-7030

EXAR Corporation reserves the right to make changes to the products contained in this publication in order to improve design, performance or reliability. EXAR Corporation assumes no responsibility for the use of any circuits described herein, conveys no license under any patent or other right, and makes no representation that the circuits are free of patent infringement. Charts and schedules contained here in are only for illustration purposes and may vary depending upon a user's specific application. While the information in this publication has been carefully checked; no responsibility, however, is assumed for inaccuracies.

EXAR Corporation does not recommend the use of any of its products in life support applications where the failure or malfunction of the product can reasonably be expected to cause failure of the life support system or to significantly affect its safety or effectiveness. Products are not authorized for use in such applications unless EXAR Corporation receives, in writing, assurances to its satisfaction that: (a) the risk of injury or damage has been minimized; (b) the user assumes all such risks; (c) potential liability of EXAR Corporation is adequately protected under the circumstances.