

User Manual

PCE-3026

**LGA1155 Intel® Core™ i7/i5/i3/
Pentium®/Celeron® PICMG 1.3
Half-size System Host Board
with DDR3 1066/1333 / Dual
Display / Dual GbE LAN**

ADVANTECH

Enabling an Intelligent Planet

Copyright

The documentation and the software included with this product are copyrighted 2012 by Advantech Co., Ltd. All rights are reserved. Advantech Co., Ltd. reserves the right to make improvements in the products described in this manual at any time without notice. No part of this manual may be reproduced, copied, translated or transmitted in any form or by any means without the prior written permission of Advantech Co., Ltd. Information provided in this manual is intended to be accurate and reliable. However, Advantech Co., Ltd. assumes no responsibility for its use, nor for any infringements of the rights of third parties, which may result from its use.

Acknowledgements

AMIBIOS is a trademark of American Megatrends Inc.

Intel[®], Core™i7/i5/i3 and Pentium[®] are trademarks of Intel[®] Corporation.

Nuvoton is a trademark of Nuvoton Technology Corp.

All other product names or trademarks are the properties of their respective owners.

Product Warranty (2 years)

Advantech warrants to you, the original purchaser, that each of its products will be free from defects in materials and workmanship for two years from the date of purchase.

This warranty does not apply to any products which have been repaired or altered by persons other than repair personnel authorized by Advantech, or which have been subject to misuse, abuse, accident or improper installation. Advantech assumes no liability under the terms of this warranty as a consequence of such events.

Because of Advantech's high quality-control standards and rigorous testing, most of our customers never need to use our repair service. If an Advantech product is defective, it will be repaired or replaced at no charge during the warranty period. For out-of-warranty repairs, you will be billed according to the cost of replacement materials, service time and freight. Please consult your dealer for more details.

If you think you have a defective product, follow these steps:

1. Collect all the information about the problem encountered. (For example, CPU speed, Advantech products used, other hardware and software used, etc.) Note anything abnormal and list any onscreen messages you get when the problem occurs.
2. Call your dealer and describe the problem. Please have your manual, product, and any helpful information readily available.
3. If your product is diagnosed as defective, obtain an RMA (return merchandise authorization) number from your dealer. This allows us to process your return more quickly.
4. Carefully pack the defective product, a fully-completed Repair and Replacement Order Card and a photocopy proof of purchase date (such as your sales receipt) in a shippable container. A product returned without proof of the purchase date is not eligible for warranty service.
5. Write the RMA number visibly on the outside of the package and ship it prepaid to your dealer.

Part No. 2006302610

Printed in China

Edition 1

October 2012

Declaration of Conformity

FCC Class A

Note: This equipment has been tested and found to comply with the limits for a Class A digital device, pursuant to part 15 of the FCC Rules. These limits are designed to provide reasonable protection against harmful interference when the equipment is operated in a commercial environment. This equipment generates, uses, and can radiate radio frequency energy and, if not installed and used in accordance with the instruction manual, may cause harmful interference to radio communications. Operation of this equipment in a residential area is likely to cause harmful interference in which case the user will be required to correct the interference at his own expense.

Caution! *There is a danger of a new battery exploding if it is incorrectly installed. Do not attempt to recharge, force open, or heat the battery. Replace the battery only with the same or equivalent type recommended by the manufacturer. Discard used batteries according to the manufacturer's instructions.*



A Message to the Customer

Advantech Customer Services

Each and every Advantech product is built to the most exacting specifications to ensure reliable performance in the harsh and demanding conditions typical of industrial environments. Whether your new Advantech equipment is destined for the laboratory or the factory floor, you can be assured that your product will provide the reliability and ease of operation for which the name Advantech has come to be known.

Your satisfaction is our primary concern. Here is a guide to Advantech's customer services. To ensure you get the full benefit of our services, please follow the instructions below carefully.

Technical Support

We want you to get the maximum performance from your products. So if you run into technical difficulties, we are here to help. For the most frequently asked questions, you can easily find answers in your product documentation. These answers are normally a lot more detailed than the ones we can give over the phone.

So please consult this manual first. If you still cannot find the answer, gather all the information or questions that apply to your problem, and with the product close at hand, call your dealer. Our dealers are well trained and ready to give you the support you need to get the most from your Advantech products. In fact, most problems reported are minor and are able to be easily solved over the phone.

In addition, free technical support is available from Advantech engineers every business day. We are always ready to give advice on application requirements or specific information on the installation and operation of any of our products.

Memory Compatibility

Brand	Size	Speed	Type	ECC	Vendor PN	Memory	Advantech PN
Transcend	1GB	DDR3 1066	SODIMM DDR3	N	TS128MSK6 4V1U	SEC K4B1G0846G- BCH9	96SD3- 1G1066NN-TR
Transcend	2GB	DDR3 1066	SODIMM DDR3	N	TS256MSK6 4V1U	SEC HCH9 K4B1G0846D (128x8)	96SD3- 2G1066NN-TR
Transcend	4GB	DDR3 1066	SODIMM DDR3	N	TS7KSN284 20-1Y	HYNIX H5TQ2G83BF R (256x8)	96SD3- 4G1066NN-TR
Apacer	4GB	DDR3 1066	SODIMM DDR3	N	78.B2GC8.A F1	HYNIX H5TQ2G83BF R (256x8)	96SD3- 4G1066NN-AP
Transcend	1GB	DDR3 1333	SODIMM DDR3	N	TS128MSK6 4V3U	ELPIDA J1108BFBG- DJ-F	96SD3- 1G1333NN-TR
Transcend	2GB	DDR3 1333	SODIMM DDR3	N	TS256MSK6 4V3N	HYNIX H5TQ2G83CF R	96SD3- 2G1333NN-TR2
Transcend	4GB	DDR3 1333	SODIMM DDR3	N	TS512MSK6 4V3N	HYNIX H5TQ2G83BF R (256x8)	96SD3- 4G1333NN-TR
Transcend	8GB	DDR3 1333	SODIMM DDR3	N	TS1GSK64V 3H	MICRON IZD27 D9PBC 79T5 512x8	96SD3- 8G1333NN-TR
Apacer	1GB	DDR3 1333	SODIMM DDR3	N	78.02GC6.A F0	HYNIX H5TQ1G83DF R-H9C	96D3- 1G1333NN-AP1
	1GB	DDR3 1333	SODIMM DDR3	N		HYNIX H5TQ1G83TF R-H9C	
Apacer	2GB	DDR3 1333	SODIMM DDR3	N	78.A2GC9.42 00C	ELPIDA J2108BCSE- DJ-F	96SD3- 2G1333NN-AP1
Apacer	4GB	DDR3 1333	SODIMM DDR3	N	78.B2GC9.A F1	HYNIX H5TQ2G83BF R (256x8)	NA
Apacer	8GB	DDR3 1333	SODIMM DDR3	N	78.C2GCM.4 230C	ELPIDA J4208BASE- DJ-F 512x8	96SD3- 8G1333NN-AP
DSL	4GB	DDR3 1333	SODIMM DDR3	N	D3SH56082 XH15AA	HYNIX H5TQ2G83BF R (256x8)	NA
DSL	2GB	DDR3 1600	SODIMM DDR3	N	D3SS56081X H12AA	SEC 113 HCK0 K4B2G0846C (256x8)	NA
DSL	4GB	DDR3 1600	SODIMM DDR3	N	D3SS56082X H12AA	SEC 113 HCK0 K4B2G0846C (256x8)	NA

Apacer	2GB	DDR3 1600	SODIMM DDR3	N	78.A2GCJ.A F00C	HYNIX H5TQ2G83CF R (256x8)	NA
Apacer	2GB	DDR3 1600	SODIMM DDR3	N	78.A2GCR.A T00C	MICRON IYM22 D9PFJ (256x8)	Low Voltage 1.35V
Apacer	4GB	DDR3 1600	SODIMM DDR3	N	78.B2GCJ.A F10C	HYNIX H5TQ2G83CF R (256x8)	NA
Transcend	2GB	DDR3 1600	SODIMM DDR3	N	TS256MSK6 4V6N	MICRON IVM77 D9PFJ	NA
Transcend	4GB	DDR3 1600	SODIMM DDR3	N	TS512MSK6 4V6N	MICRON 2DM77 D9PFJ 256x8	NA
Transcend	4GB	DDR3 1600	SODIMM DDR3	N	TS512MSK6 4N6N	MICRON IRM72 D9PFJ	NA
Transcend	8GB	DDR3 1600	SODIMM DDR3	N	TS1GSK64V 6H	MICRON IZD27 D9PBC 79T5 512x8	96SD3- 8G1600NN-TR
ATP	8GB	DDR3 1600	SODIMM DDR3	N	AW24M64F8 BLK0S	SEC 140 HYK0 K4B4G0846B 512x8	96SD3- 8G1600NN-AT

Processor Support

Processor	PN	Base Frequency	L3 Cache	Max TDP
Core i7-3770		3.4 GHz	8 MB	77 W
Core i7-2600		3.4 GHz	8 MB	95 W
Core i5-3550S		3.0 GHz	6 MB	65 W
Core i5-2400		3.1 GHz	3 MB	95 W
Core i3-3220		3.3 GHz	3 MB	55 W
Core i3-2120		3.3 GHz	3 MB	65 W
Pentium G2120		3.1 GHz	3 MB	55 W
Pentium G850		2.9 GHz	3 MB	65 W
Celeron G540		2.5 GHz	2 MB	65 W
Core i3-2100T		2.5 GHz	3 MB	35 W
Core i5-2390T		2.7 GHz	3 MB	35 W

Note!  The processor information is from Intel. If there are any differences between the table and their announcement, please align with the information officially released by Intel.

Suggested CPU Cooler List

CPU Maximum TDP (W)	CPU Cooler P/N	Cooler Height
Core i7-3770, i7-2600, i5-3550S, i5-2400, i3-3220, i3-2120, Pentium G2120, G850, Celeron G540	1960047831N001	2U
Core i7-2600, i5-3550S, i5-2400, i3-3220, i3-2120, Pentium G2120, G850, Celeron G540	1960053207N001	1.5U

Backplane Support

PCE-3BXX series

Operating System Support

Win 7 SP1 (32/64 bit), Win XP SP3 (32/64 bit), Linux, QNX, XPE (32 bit), WES (32/64 bit)

Initial Inspection

Before you begin installing your motherboard, please make sure that the following materials have been shipped:

- 1 PCE-3026 PICMG 1.3 Half-size Single Host Board
- 1 PCE-3026 startup manual P/N: 2006302600
- 1 CD with utility P/N: 2066302600
- 1 Serial ATA HDD data cable P/N: 1700003194
- 1 Serial ATA HDD power cable P/N: 1703150102
- 1 two-port COM cable P/N: 1700008762
- 1 LPT cable P/N: 1700002223
- 1 four-port USB cable P/N: 1700014398
- 1 power converter (connected from peripheral power connector on power supply to PWR1 on board) P/N: 1703040100
- 1 warranty card

If any of these items are missing or damaged, contact your distributor or sales representative immediately. We have carefully inspected PCE-3026 mechanically and electrically before shipment. It should be free of marks and scratches and in perfect working order upon receipt. As you unpack PCE-3026, check it for signs of shipping damage. (For example, damaged box, scratches, dents, etc.) If it is damaged or it fails to meet the specifications, notify our service department or your local sales representative immediately. Also notify the carrier. Retain the shipping carton and packing material for inspection by the carrier. After inspection, we will make arrangements to repair or replace the unit.

Contents

Chapter 1	Hardware Configuration	1
1.1	Introduction	2
1.2	Features & Benefits	2
1.3	Specifications	3
1.3.1	System	3
1.3.2	Memory	3
1.3.3	Input/Output	3
1.3.4	Graphics	3
1.3.5	Ethernet LAN	3
1.3.6	Industrial features	4
1.3.7	Mechanical and environmental specifications	4
1.4	Jumpers and Connectors	4
	Table 1.1: Jumper list	4
	Table 1.2: Connectors	4
1.5	Board Layout: Jumper and Connector Locations	5
	Figure 1.1 Jumper and connector locations	5
1.6	Block Diagram	6
	Figure 1.2 PCE-3026 Block Diagram	6
1.7	Safety Precautions	6
1.8	Jumper Settings	7
1.8.1	How to set jumpers	7
1.8.2	BIOS CMOS (JCMOS1)	7
	Table 1.3: Clear BIOS CMOS (JCMOS1)	7
1.8.3	Hardware monitor alarm (JOBS1) and Watchdog timer output (JWDT1)	8
	Table 1.4: H/W monitor alarm and Watchdog timer (JOBS1+JWDT1)	8
1.9	Keyboard Lock and Buzzer Setting	9
	Table 1.5: Keyboard lock (KL1)	9
	Table 1.6: Buzzer setting (BZ1)	9
1.10	System Memory	9
1.11	Memory Installation Procedures	10
1.12	Cache Memory	10
1.13	Processor Installation	11
1.14	Processor Cooler Installation	13
Chapter 2	Connecting Peripherals	15
2.1	Introduction	16
2.2	Parallel Port (LPT1)	16
2.3	USB Ports (USB12, USB34, USB56, USB7, USB8)	17
2.4	VGA Connector (VGA1)	17
2.5	DVI Connector (DVI 1)	18
2.6	Serial Ports (COM12)	18
2.7	PS/2 Keyboard and Mouse Connector (KBMS1)	19
2.8	CPU Fan Connector (CPUFAN1)	19
2.9	Front Panel Connectors (FP1)	20
2.10	H/W Monitor/Watchdog Timer/Infrared	20
2.10.1	H/W monitor alarm (JOBS1)	21
2.10.2	Watchdog timer (JWDT1)	21
2.10.3	Infrared interface (JIR1)	21
2.11	LAN Ports (LAN1 & LAN2)	21
	Table 2.1: LAN LED Indicators	22
2.12	High Definition Audio Module Interface (HDAUD1)	22

	Figure 2.1 Jumper and connector locations of PCA-AUDIO-HDA1E	23
2.13	GPIO Header (GPIO1).....	24
2.14	Case Open Connector (JCASE1).....	24
2.15	Front Panel LAN Indicator Connector (LANLED1).....	25
	Table 2.2: LAN LED Indicators	25
2.16	Serial ATA Interface (SATA1~SATA3).....	26
2.17	LPC Extension Interface (LPC1).....	26
2.18	12/5v power connector (PWR1).....	27

Chapter 3 AMI BIOS Setup..... 29

3.1	Introduction	30
	Figure 3.1 Setup program initial screen.....	30
3.2	Entering Setup	31
3.2.1	Main Setup.....	31
	Figure 3.2 Main setup screen	31
3.2.2	Advanced BIOS Features Setup.....	32
	Figure 3.3 Advanced BIOS features setup screen	32
	Figure 3.4 Advantech BIOS Update V1.3.....	33
	Figure 3.5 PCI Subsystem Settings.....	33
	Figure 3.6 PCI Express Settings	34
	Figure 3.7 ACPI Settings	35
	Figure 3.8 Trust Computing.....	36
	Figure 3.9 S5 RTC configuration	37
	Figure 3.10 CPU Configuration	37
	Figure 3.11 SATA Configuration.....	38
	Figure 3.12 Intel Trusted Execution Technology Configuration... ..	39
	Figure 3.13 USB Configuration.....	40
	Figure 3.14 Smart Setting.....	41
	Figure 3.15 Super IO Configuration.....	41
	Figure 3.16 Serial Port 1 Configuration	42
	Figure 3.17 Serial Port 2 Configuration	42
	Figure 3.18 Parallel Configuration	43
	Figure 3.19 PC Health Status	44
	Figure 3.20 CPU PPM Configuration.....	45
3.2.3	Chipset.....	46
	Figure 3.21 Chipset	46
	Figure 3.22 PCH IO Configuration.....	47
	Figure 3.23 PCI Express Configuration	47
	Figure 3.24 USB Configuration.....	48
	Figure 3.25 PCH Azalia Configuration.....	49
	Figure 3.26 System Agent (SA) Configuration	50
	Figure 3.27 Graphics Configuration.....	51
	Figure 3.28 NB PCIe Configuration	52
	Figure 3.29 Memory Information	53
3.2.4	Boot	53
	Figure 3.30 Boot	53
3.2.5	Security.....	54
	Figure 3.31 Security	54
3.2.6	Save & Exit	55
	Figure 3.32 Save & Exit.....	55

Chapter 4 Value-Added Software Services 57

4.1	Value-Added Software Services	58
4.1.1	Software API.....	58

Chapter	5	Chipset Software Installation Utility	59
	5.1	Before You Begin	60
	5.2	Introduction	60
	5.3	Windows® XP / Windows® 7 Driver Setup	61
Chapter	6	Integrated Graphic Device Setup	63
	6.1	Introduction	64
	6.2	Windows XP/Windows 7 Driver Setup	64
Chapter	7	LAN Configuration	65
	7.1	Introduction	66
	7.2	Installation	66
	7.3	Win XP /Win 7 Driver Setup (LAN).....	66
Chapter	8	Intel ME	67
	8.1	Introduction	68
	8.2	Installation	68
Appendix A		Programming the Watchdog Timer	69
	A.1	Introduction	70
	A.1.1	Watchdog timer overview.....	70
	A.1.2	Programming the watchdog timer	70
		Table A.1: Watchdog timer registers.....	71
	A.1.3	Example program.....	72
Appendix B		I/O Pin Assignments	77
	B.1	Parallel Port Connector (LPT1).....	78
		Table B.1: Parallel port connector (LPT1).....	78
	B.2	VGA Connector (VGA1).....	78
		Table B.2: VGA connector (VGA1)	78
	B.3	RS 232 Serial Port (COM12).....	79
		Table B.3: RS-232 serial port (COM12).....	79
	B.4	USB 2.0 Header (USB12~56).....	80
		Table B.4: USB Header (USB12~56, take USB 12 as example).....	80
	B.5	PS/2 Keyboard/Mouse Connector (KBMS1).....	80
		Table B.5: PS/2 keyboard/mouse connector (KBMS1).....	80
	B.6	CPU Fan Power Connector (CPUFAN1)	81
		Table B.6: CPU fan power connector (CPUFAN1)	81
	B.7	Reset Connector (FP1 / RESET)	81
		Table B.7: Reset connector (FP1 / RESET)	81
	B.8	Hi-definition Audio Link Connector (HDAUD1).....	82
		Table B.8: Hi-definition audio link connector (HDAUD1)	82
	B.9	LAN1 and LAN2 LED Connector (LANLED1)	82
		Table B.9: LAN1 and LAN2 LED connector (LANLED1)	82
	B.10	GPIO Header (GPIO1).....	83
		Table B.10:GPIO header (GPIO1).....	83
	B.11	JIR1	83
		Table B.11:JIR1	83
	B.12	JCASE1.....	84

	Table B.12:JCASE1	84
B.13	LPC1	84
	Table B.13:LPC1	84
B.14	PWR1.....	85
	Table B.14:PWR1	85
B.15	DVI1	85
	Table B.15:DVI1	85
B.16	Fixed I/O Ranges Decoded by Intel PCH	86
	Table B.16:Fixed I/O Ranges Decoded by Intel PCH.....	86
B.17	System I/O Ports.....	88
	Table B.17:System I/O Ports	88
B.18	Interrupt Assignments	88
	Table B.18:Interrupt Assignments	88
B.19	1 MB Memory Map.....	89
	Table B.19:1 MB memory map	89

Appendix C Programming the GPIO 91

C.1	Supported GPIO Register	92
C.2	GPIO Registers.....	92
C.3	GPIO Example Program-1	92

Chapter 1

Hardware
Configuration

1.1 Introduction

PCE-3026 is a PICMG 1.3 half-size system host board which is designed with Intel® H61 PCH for industrial applications that need high computing power in compact-sized systems. PCE-3026 supports 22 nm manufacturing technology, LGA1155 socket Intel® Core™ i7/i5/i3, and Pentium® and Celeron processors with integrated graphics and support for DDR3 1066/1333 MHz SDRAM up to 8 GB. By supporting advanced computing technology, PCE-3026 is a very cost-effective embedded solution for high performance compact systems.

PCE-3026 performs excellent graphic processing capability through its integrated Intel® HD Graphics graphics core. In addition, PCE-3026 supports VGA+DVI dual display and SG mode. If VGA expansion is installed, PCE-3026 can support more than two display interfaces. These two features enhance the display capability, and satisfy display applications in video walls, AOI, or medical computing.

PCE-3026 also has rich I/O interfaces, and it can support Advantech PCE-3BXX backplanes with expansion slots such as PCIe and PCI. PCE-3026 supports two GbE LAN, eight USB 2.0, three SATA 2.0, and up to two RS-232 and four RS-422/485 ports for general industrial applications. With flexible I/O and graphic capability, PCE-3026 can be an cost effective graphic or I/O oriented desktop platform. With outstanding performance and exceptional features, PCE-3026 is the ideal compact system solution in advanced industrial applications.

1.2 Features & Benefits

Features	Benefits
PCE-3026 Supports Intel 3rd and 2nd Generation processors	Intel's 3rd and 2nd generation Core i7/i5/i3/Pentium/Celeron processor cores with quad/dual-core computing power bring quantum-leap performance improvement.
PCE-3026 supports DDR3 1066/1333 SDRAM up to 8 GB	The feature provides higher memory data transmission and processing efficiency, bringing higher system performance.
Compact size	PCE-3026 is compliant with PICMG 1.3 Half-size specification. The size is only 167.64 mm x 126.39 mm (6.6" x 4.98")
Fully supports Advantech SUSI APIs and Utilities.	Reduces customer's S/W development effort with more reliable S/W quality, also it provides value-added utilities such as system monitor and Embedded Security ID.
USB type A connector support	PCE-3026 support one type A USB connector on board for dongle devices. This enhances information security.

1.3 Specifications

1.3.1 System

- **CPU:** LGA1155-socket Core i7/i5/i3, Pentium and Celeron series processors
- **L2 Cache:** Please refer to processor support list for detailed information
- **BIOS:** AMI SPI BIOS (64 Mb SPI)
- **System Chipset:** Intel H61
- **SATA hard disk drive interface:** 3 x SATA 2.0 (300 MB/s)

Note! PCE-3026 does NOT support PATA(IDE) interface.



1.3.2 Memory

- **RAM:** Up to 8 GB in two 204-pin SO-DIMM sockets (4 GB per DIMM). Supporting Dual channel DDR3 1066/1333 MHz SO-DIMM (Non-ECC)

1.3.3 Input/Output

- **Backplane Support:** PCE-3BXX
- **Enhanced parallel port:** This EPP/SPP/ECP port can be configured to LPT1, LPT2, LPT3 or disabled
- **Serial ports:** Two RS-232 serial ports on board. Four RS 422/485 serial ports supported by optional COM module via low pin count connector (P/N: PCA-COM485-00A1E)
- **PS/2 keyboard and mouse connector:** One 6-pin mini-DIN connectors is located on the mounting bracket
- **USB port:** Supports 8 USB 2.0 ports with transfer rate up to 480 Mbps. (6 on board, 1 on rear I/O, 1 Type A USB on board.)

1.3.4 Graphics

- **Controller:** Intel® HD Graphics embedded in the processor
- **Display memory:** Shared memory is subject to OS
- **CRT:** Resolution can be up to 2560 x 1600
- **DVI:** Resolution can be up to 1920 x 1080 (Please place order on optional DVI cable: 1700008822)
- **PCI express x16 slot on the backplane:** An external graphic card can be installed in the PCI-E x 16 slot for stronger 2D/3D graphic capability

1.3.5 Ethernet LAN

- Supporting dual 10/100/1000 Mbps Ethernet port via the dedicated PCI Express x1 bus which provides 500 MB/s data transmission rate
- **Controller:**
 - LAN 1: Intel® 82579V (PHY)
 - LAN 2: Intel® 82583V

1.3.6 Industrial features

- **Watchdog timer:** Can generate a system reset. The watchdog timer is programmable, with each unit equal to one second or one minute (255 levels).

1.3.7 Mechanical and environmental specifications

- **Operating temperature:** 0 ~ 60° C (32 ~ 140° F, Depending on CPU)
- **Storage temperature:** -40 ~ 85° C (-40 ~ 185° F)
- **Humidity:** 20 ~ 95% non-condensing
- **Power supply voltage:** +3.3 V, +5 V, +12 V, +5 V_{SB}

- **Power consumption:**

Voltage (V)	3.3	5	12	5VSB
Current (A)	1.54	1.05	3.8	0.24
Power consumption (W)	5.173	5.304	45.866	1.203

- **Test condition:**
- **CPU:** Intel Core i5-2400 (3.1 GHz)
- **Memory:** DDR3 1333 4GB *2
- **Board size:** 167.64 mm (L) X 126.39 mm (W) (6.6" x 4.98")
- **Board weight:** 0.33 kg

1.4 Jumpers and Connectors

Connectors on PCE-3026 system host board link it to external devices such as hard disk drives and a keyboard. In addition, the board has a number of jumpers used to configure your system for your application.

The tables below list the function of each of the board jumpers and connectors. Later sections in this chapter give instructions on setting jumpers. Chapter 2 gives instructions for connecting external devices to your motherboard.

Table 1.1: Jumper list

Label	Function
JCMOS1	CMOS clear
JOBS1+JWDT1	Hardware monitor alarm+watchdog timer output selection
BZ1	Buzzer setting
KL1	Keyboard lock

Table 1.2: Connectors

Label	Function
LPT1	Parallel port, supports SPP/EPP/ECP mode
LAN1	Intel® 82579V
LAN2	Intel® 82583V
VGA1	VGA connector
KBMS1	External keyboard/mouse connector
COM12	Box header for RS-232*2
JIR1	Infrared connector
FP1	Power Switch / Reset connector
JCASE1	Case Open

CPUFAN1	CPU FAN connector (4-pin)
LANLED1	LAN1/2 LED connector
HDAUD1	HD audio extension module connector
USB12	USB port 1, 2
USB34	USB port 3, 4
USB56	USB port 5, 6
USB7	USB port 7
USB8	USB on rear I/O
SATA1	Serial ATA1
SATA2	Serial ATA2
SATA3	Serial ATA3
CPU1	CPU Socket
DIMMA1	Memory connector channel A
DIMMB1	Memory connector channel B
GPIO1	GPIO pin header
LPC1	Low pin count module expansion pinheader
PWR1	12 V, 5 V power connector
DVI1	DVI connector

1.5 Board Layout: Jumper and Connector Locations

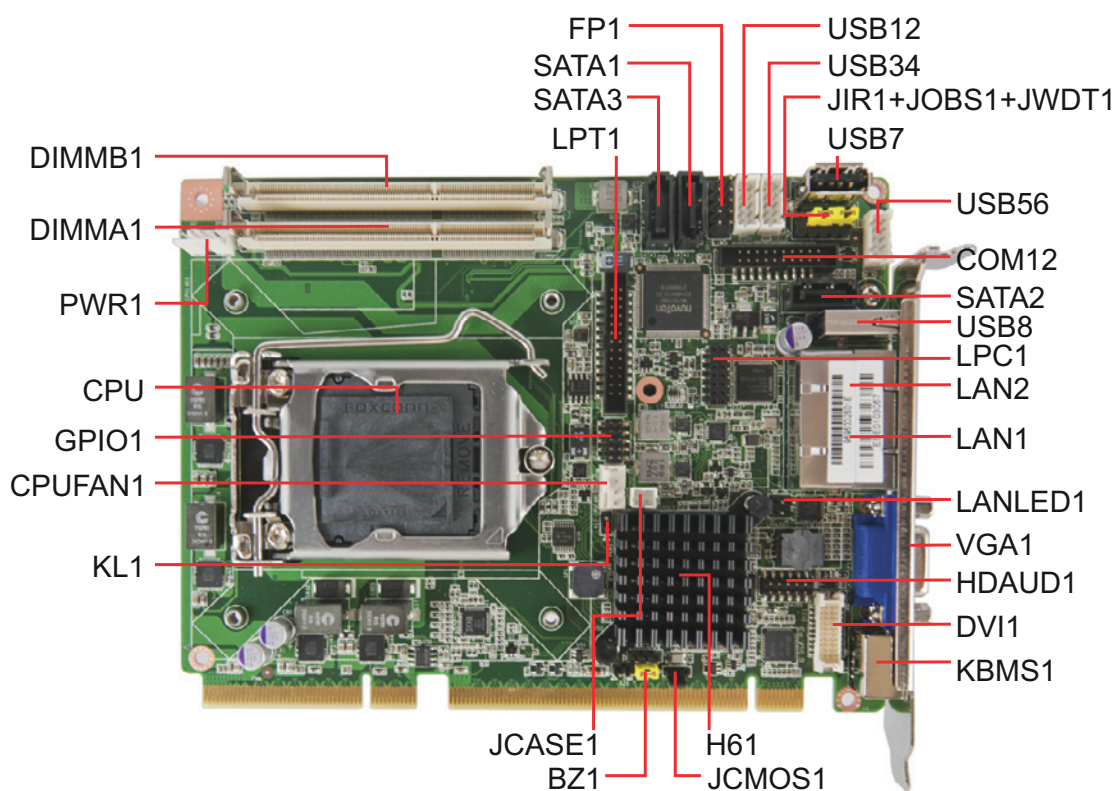

Figure 1.1 Jumper and connector locations

1.6 Block Diagram

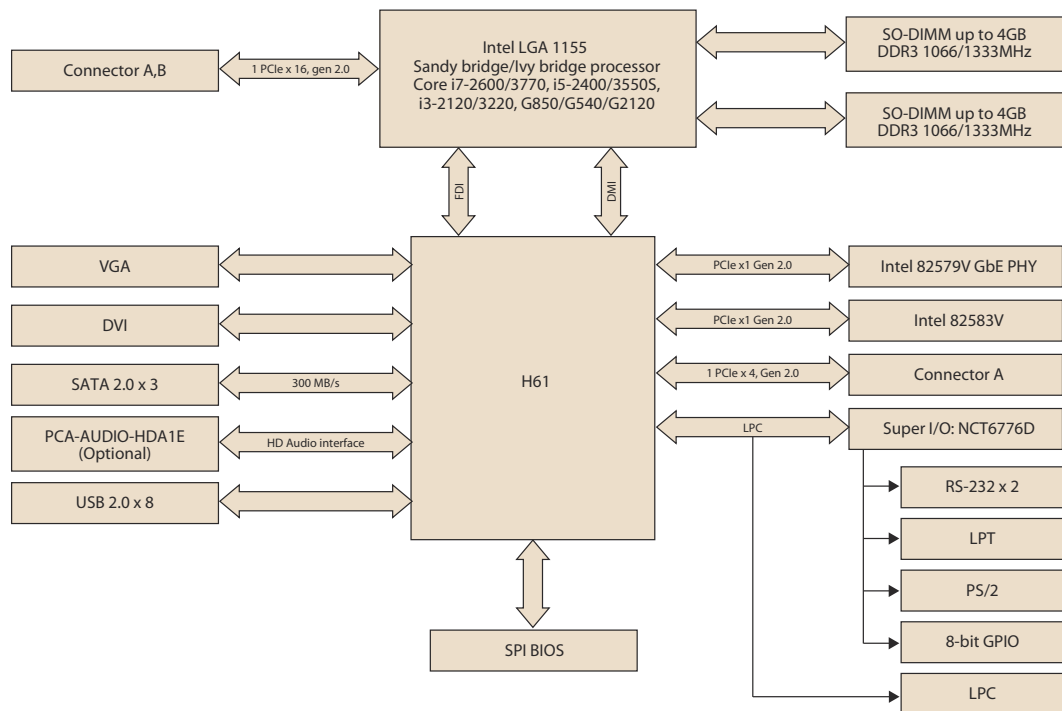

Figure 1.2 PCE-3026 Block Diagram

1.7 Safety Precautions

Warning! Always completely disconnect the power cord from your chassis whenever you work with the hardware. Do not make connections while the power is on. Sensitive electronic components can be damaged by sudden power surges. Only experienced electronics personnel should open the PC chassis.



Caution! Always ground yourself to remove any static charge before touching the motherboard. Modern electronic devices are very sensitive to static electrical discharges. As a safety precaution, use a grounding wrist strap at all times. Place all electronic components on a static-dissipative surface or in a static-shielded bag when they are not in the chassis.



Caution! The computer is provided with a battery-powered Real-time Clock. There is a danger of explosion if battery is incorrectly replaced. Replace only with same or equivalent type recommended by the manufacturer. Discard used batteries according to manufacturer's instructions.



Caution! There is a danger of a new battery exploding if it is incorrectly installed. Do not attempt to recharge, force open or heat the battery. Replace the battery only with the same or equivalent type recommended by the manufacturer. Discard used batteries according to the manufacturer's instructions.



1.8 Jumper Settings

This section provides instructions on how to configure your motherboard by setting the jumpers. It also includes the motherboard's default settings and your options for each jumper.

1.8.1 How to set jumpers

You can configure your motherboard to match the needs of your application by setting the jumpers. A jumper is a metal bridge that closes an electrical circuit. It consists of two metal pins and a small metal clip (often protected by a plastic cover) that slides over the pins to connect them. To “close” (or turn ON) a jumper, you connect the pins with the clip. To “open” (or turn OFF) a jumper, you remove the clip. Sometimes a jumper consists of a set of three pins, labeled 1, 2 and 3. In this case you connect either pins 1 and 2, or 2 and 3. A pair of needle-nose pliers may be useful when setting jumpers.

1.8.2 BIOS CMOS (JCMOS1)

PCE-3026 CPU card contains a jumper that can erase BIOS CMOS data and reset the system BIOS information. Normally this jumper should be set with pins 1-2 closed. If you want to reset those data, set JCMOS1 to 2-3 closed for just a few seconds, and then move the jumper back to 1-2 closed. This procedure will reset the CMOS to its last status or default setting.

Table 1.3: Clear BIOS CMOS (JCMOS1)

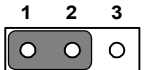
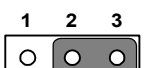
Function	Jumper Setting
*Keep BIOS CMOS data	 1-2 closed
Clear BIOS CMOS data	 2-3 closed
* default setting	

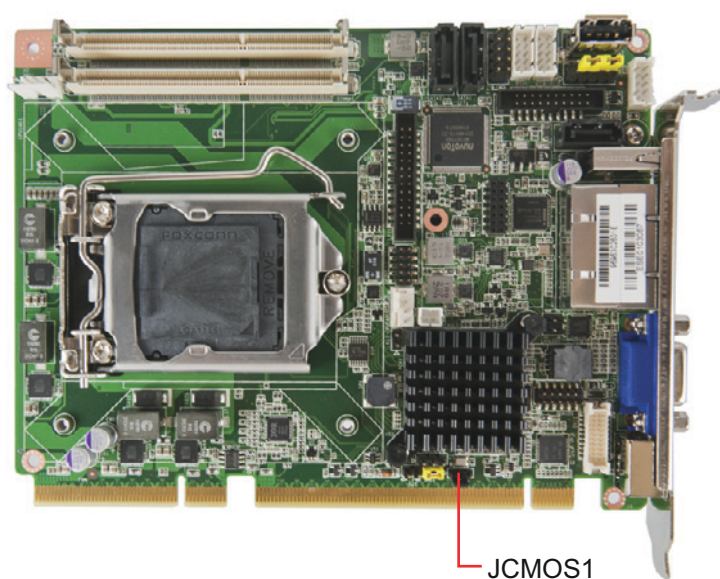

1.8.3 Hardware monitor alarm (JOBS1) and Watchdog timer output (JWDT1)

PCE-3026 contains a watchdog timer that will reset the CPU in the event the CPU stops processing. This feature means PCE-3026 will recover from a software failure or an EMI problem. The JWDT1 jumper settings control the outcome of what the computer will do in the event the watchdog timer is tripped.

PCE-3026 also provide jumper: JOBS1 to enable or disable hardware monitor function.

Table 1.4: H/W monitor alarm and Watchdog timer (JOBS1+JWDT1)

Function	Jumper Setting
*Enable watchdog timer	<p>2 4 6 8 10</p> <p>1 3 5 7 9</p>
*Enable H/W monitor alarm	<p>2 4 6 8 10</p> <p>1 3 5 7 9</p>
*default setting	

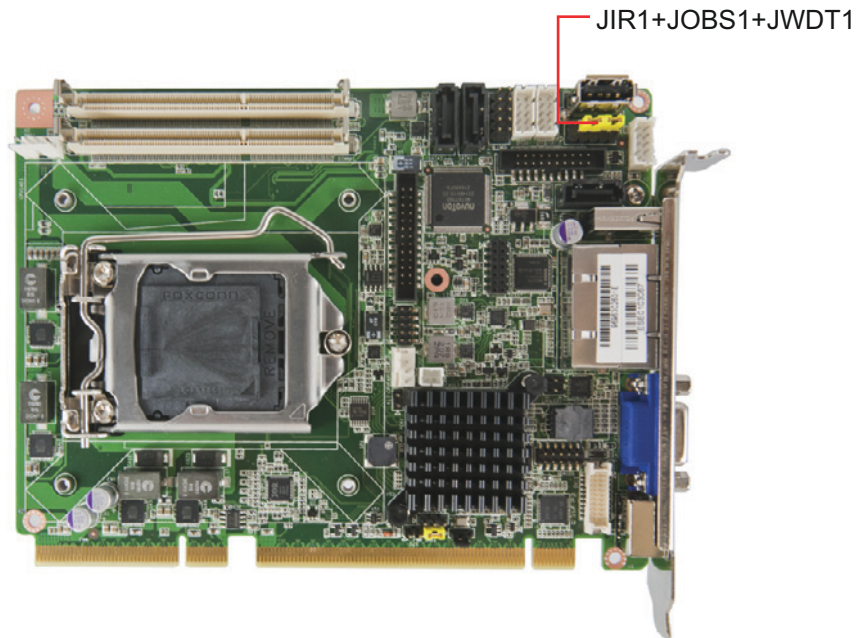

1.9 Keyboard Lock and Buzzer Setting

PCE-3026 provides jumpers for customer to enable keyboard lock and buzzer via hardware settings.

Table 1.5: Keyboard lock (KL1)

Function	Jumper Setting
*Disable keyboard lock	 Open
Enable keyboard lock	 Close
* default setting	

Table 1.6: Buzzer setting (BZ1)

Function	Jumper Setting
Connecting to external speaker	Connect 1 & 4
*Enable buzzer	
* default setting	

1.10 System Memory

PCE-3026 has two 204-pin memory sockets DDR3 1066/1333 MHz memory modules with maximum capacity of 8 GB. (Maximum 4 GB for each DIMM)

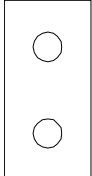
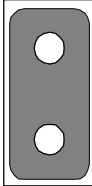
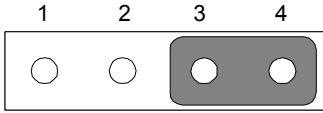
Note! PCE-3026 does NOT support registered DIMMs (RDIMMs).



1.11 Memory Installation Procedures

To install DIMMs, first, insert the memory module in the socket.

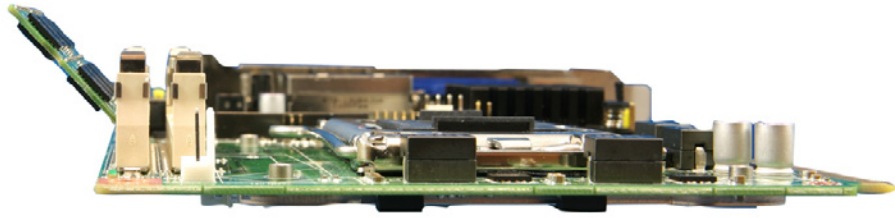

Then softly push the whole memory into the socket. when a "click" is heard, the installation is successful.

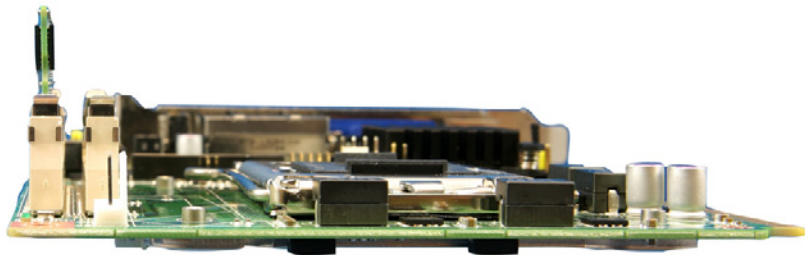

1.12 Cache Memory

CPUs supported by PCE-3026 have 8 MB, 6 MB, 3 MB, 2MB L3 cache memory sizes.

Note! Please refer to Intel CPU data sheet for detail information.



1.13 Processor Installation

Warning! Without a fan or heat sink, the processor will overheat and cause damage to both the processor and the single board computer. To install a processor, first turn off your system.



PCE-3026 is designed for Intel® LGA 1155 socket processors. For the CPU installation process, please follow the steps below.

1. Pull the handle beside the processor socket outward and lift it.

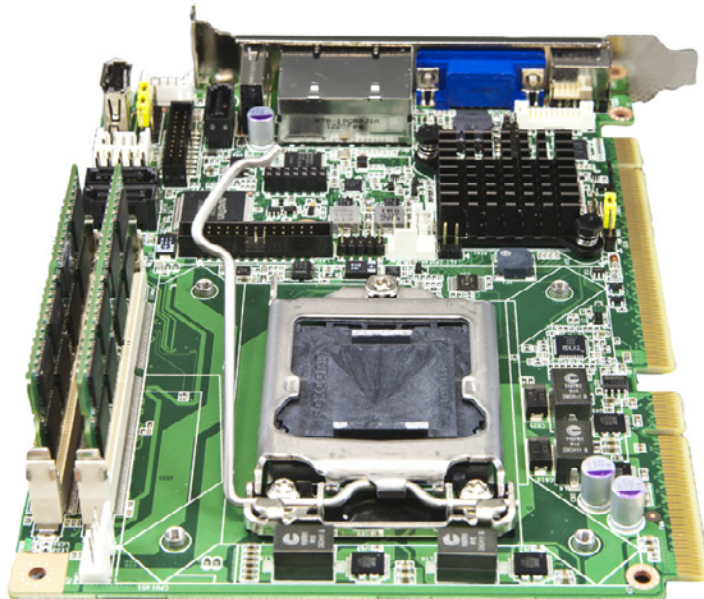

2. Remove the socket protection cap.

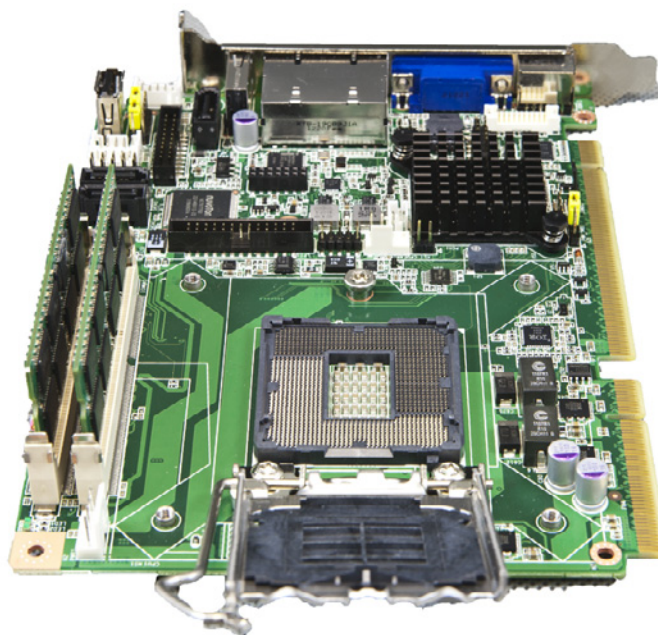

3. Align the cuts on the processor with the edges of the socket.

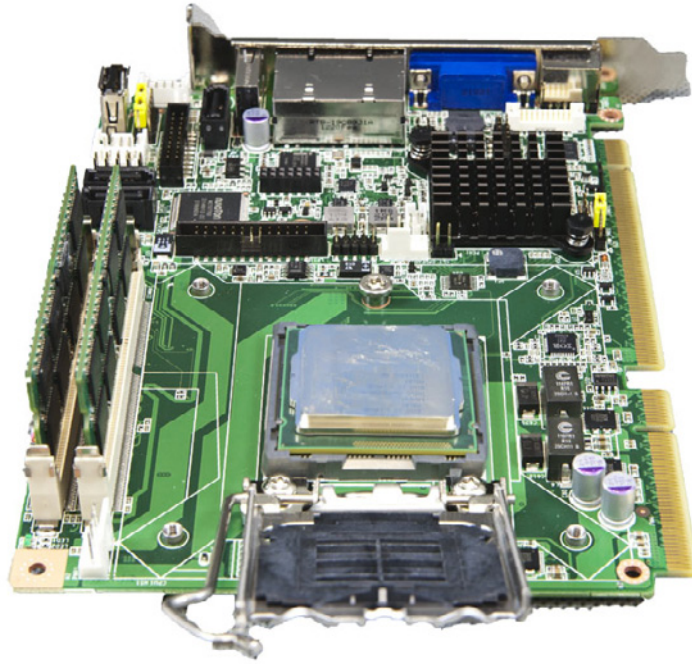

4. Replace the socket cap; lower the retainer handle and clip it shut.

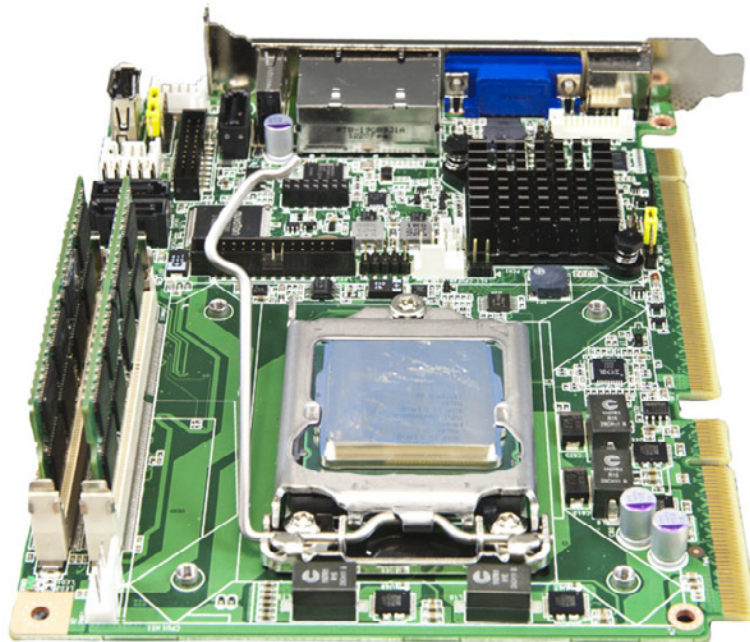

5. Processor installation is complete.

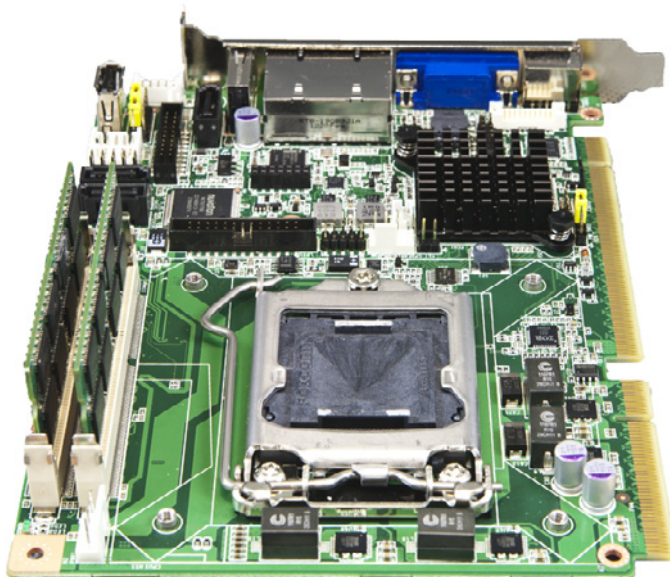

1.14 Processor Cooler Installation

Purchasing PCE-3026's proprietary CPU cooler from Advantech is necessary. Other brand CPU coolers are NOT compatible with PCE-3026.

Advantech offers a specially designed CPU cooler for PCE-3026 for better heat dissipation efficiency and enhancing rigidity of the CPU card.

Attach the CPU cooler on the CPU card by fastening four screws on the cooler into the steel back-plate on the PCB.

Note the direction of CPU cooler; it must follow that shown below. Installing a CPU cooler in the wrong direction may cause poor heat dissipation and damage the CPU card.

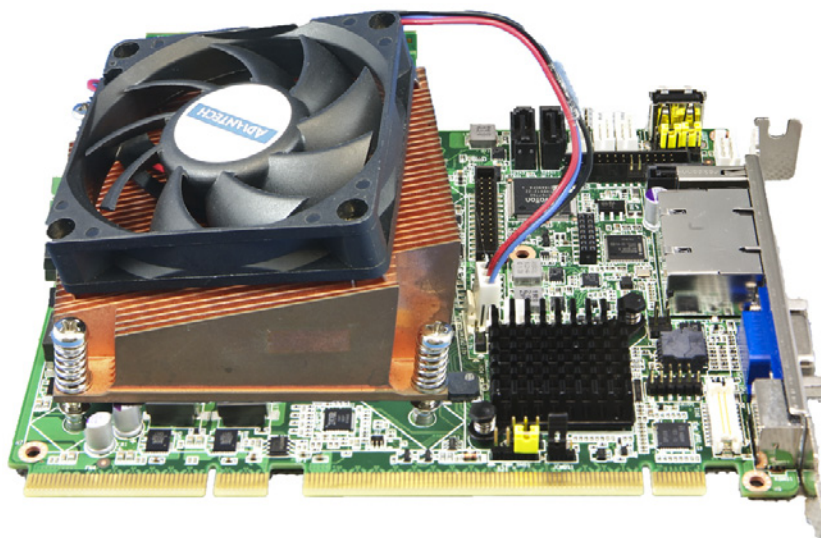

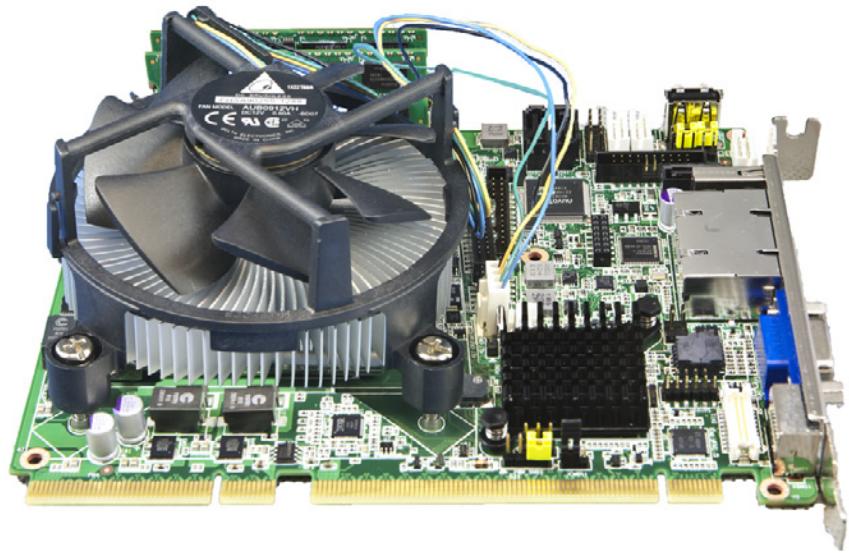

Chapter 2

Connecting
Peripherals

2.1 Introduction

You can access most of the connectors from the top of the board. If you have a number of cards installed, you may need to partially remove a card to make all the connections.

2.2 Parallel Port (LPT1)

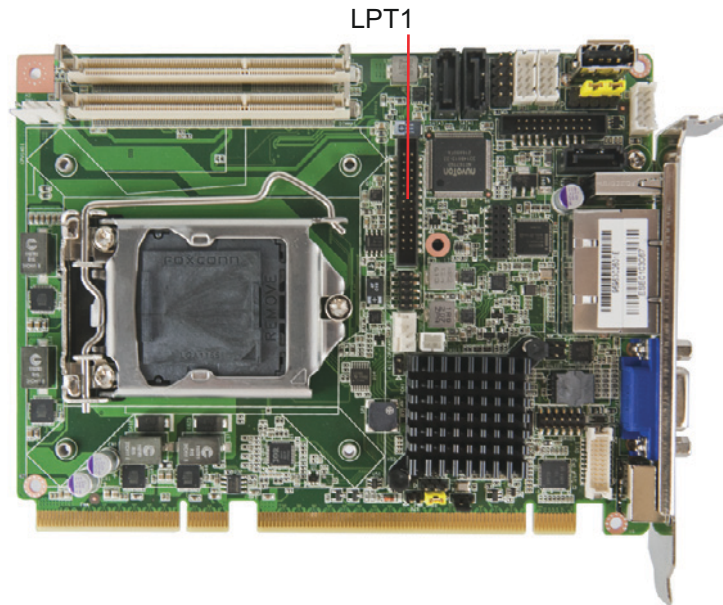

The parallel port is normally used to connect the motherboard to a printer. PCE-3026 includes an onboard parallel port, accessed through a 26-pin flat-cable connector, LPT1.

2.3 USB Ports (USB12, USB34, USB56, USB7, USB8)

PCE-3026 provides up to 8 USB (Universal Serial Bus) on-board ports with complete Plug & Play and hot swap support for up to 127 external devices. These USB ports comply with USB Specification 2.0, support transfer rates up to 480 Mbps. USB 1-6 ports are located on board with box header, USB7 is a type A connector, and USB8 is on rear I/O bracket. The USB interface can be disabled in the system BIOS setup.

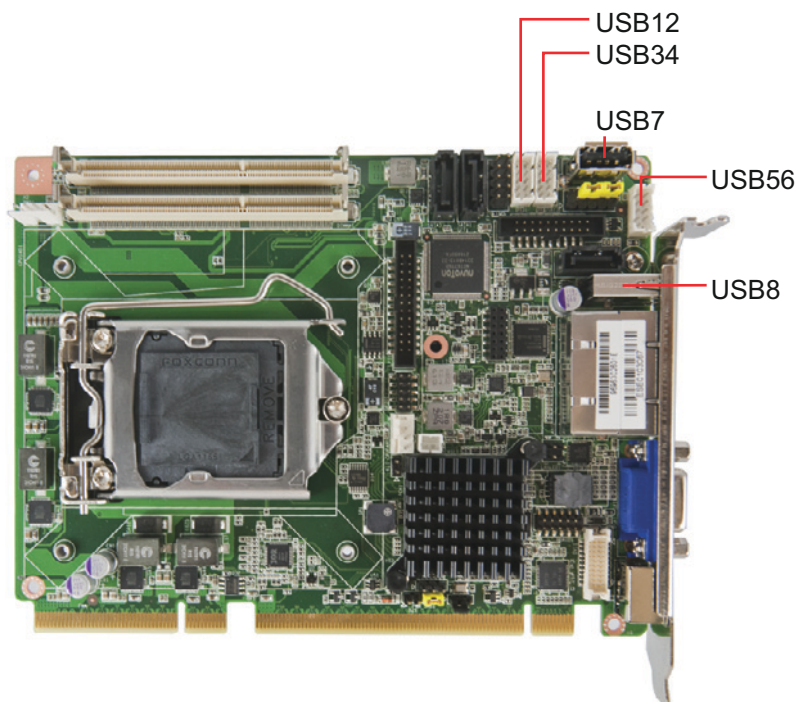

2.4 VGA Connector (VGA1)

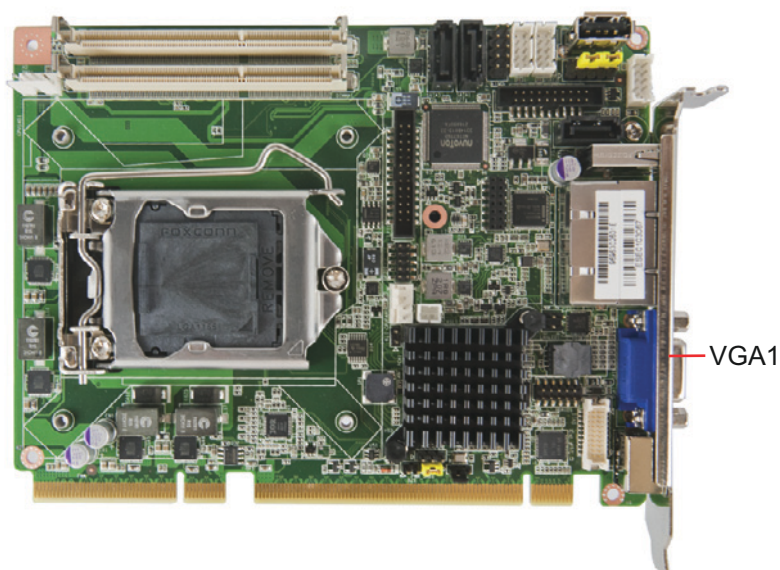

This CPU card has VGA outputs that can drive conventional CRT displays. VGA1 is a standard 15-pin D-SUB connector commonly used for VGA.

2.5 DVI Connector (DVI 1)

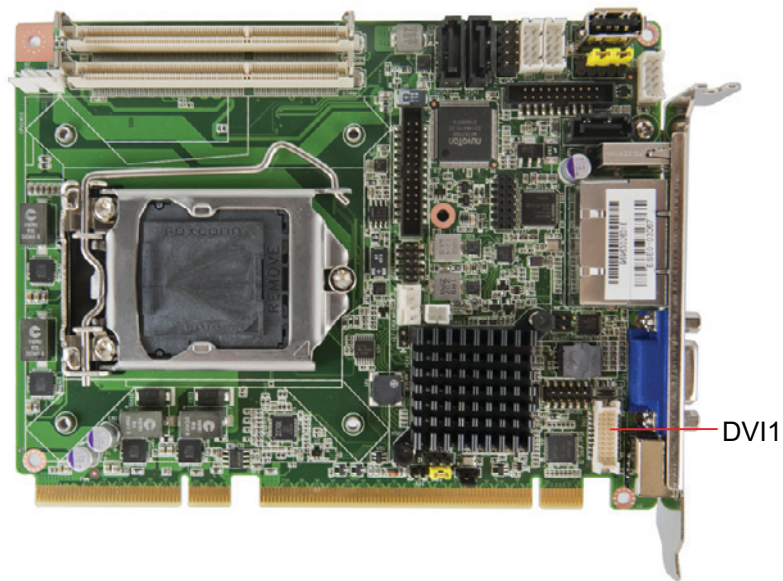

DVI 1 is a 20-pin connector, supporting resolution up to 1920x1080. Please place order no. 1700008822 for standard DVI connector on bracket.

2.6 Serial Ports (COM12)

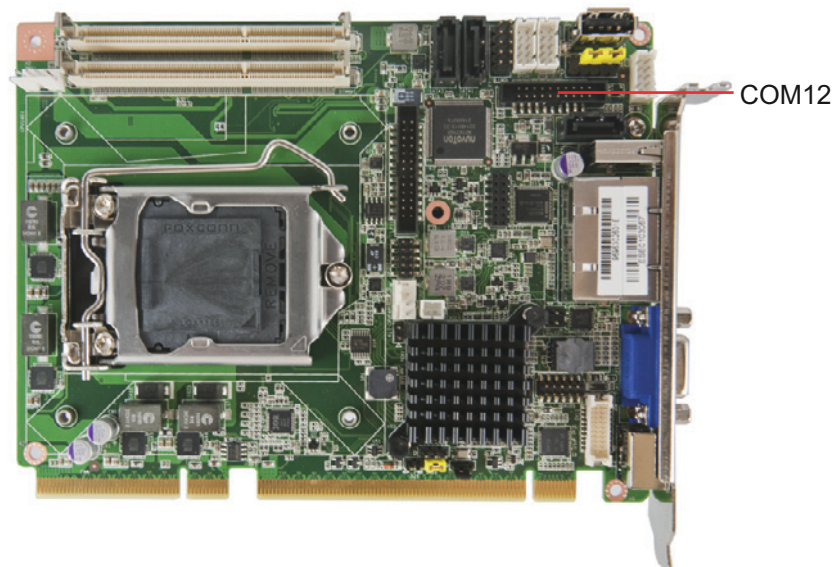

PCE-3026 offers two serial ports. These ports can connect to serial devices, such as a mouse or a printer, or to a communications network. The IRQ and address ranges for both ports are fixed. However, if you want to disable the port or change these parameters later, you can do this in the system BIOS setup.

2.7 PS/2 Keyboard and Mouse Connector (KBMS1)

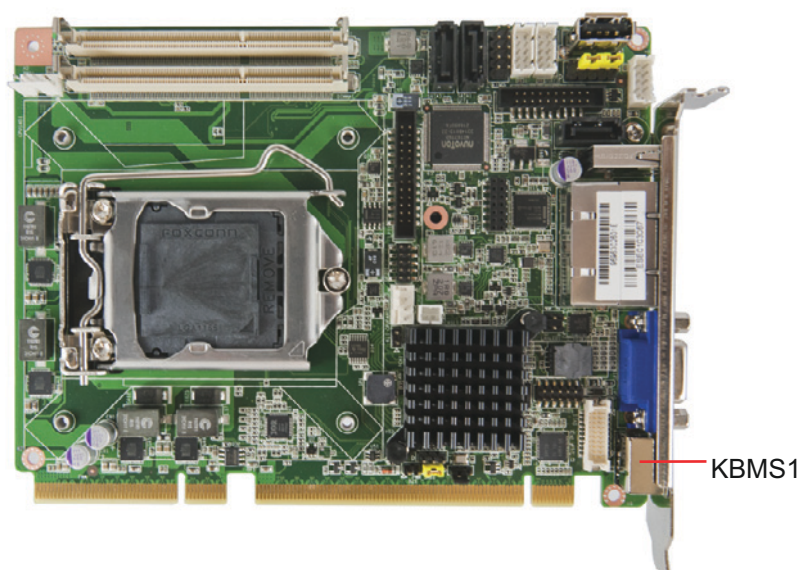

Two on-board 6-pin mini-DIN connectors (KBMS1) provide connection to PS/2 keyboard. If a Y cable is required, please place an order for no. 1700060202.

2.8 CPU Fan Connector (CPUFAN1)

This connector supports cooling fans of 500 mA (6 W) or less, and it also supports smart fan control when using 4-pin or 3-pin cooler.

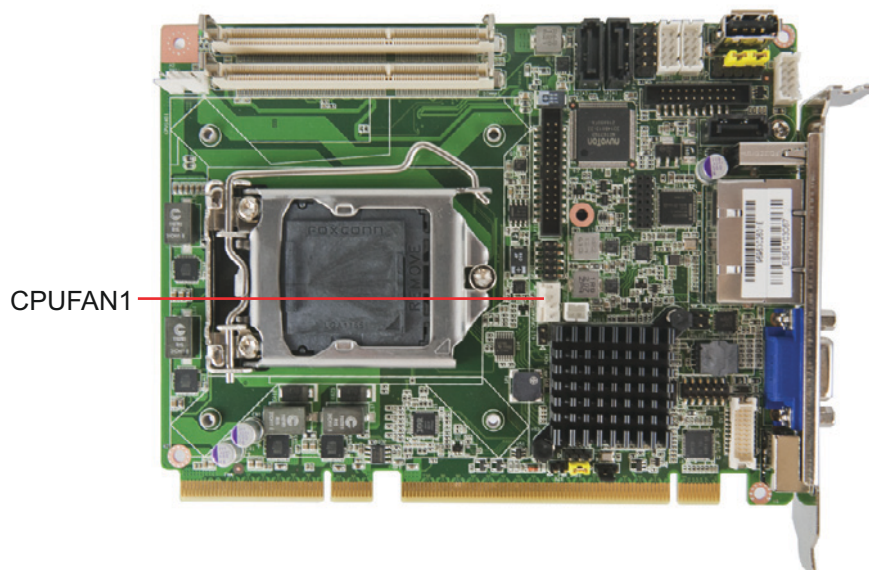

2.9 Front Panel Connectors (FP1)

FP1 is a 10-pin connector which connects to the front panel switch to control system power on/off and reset.

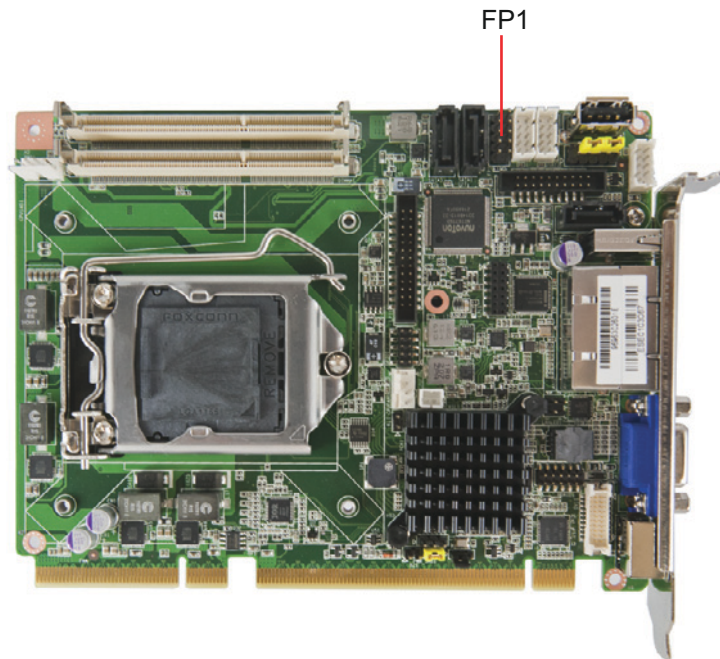

2.10 H/W Monitor/Watchdog Timer/Infrared

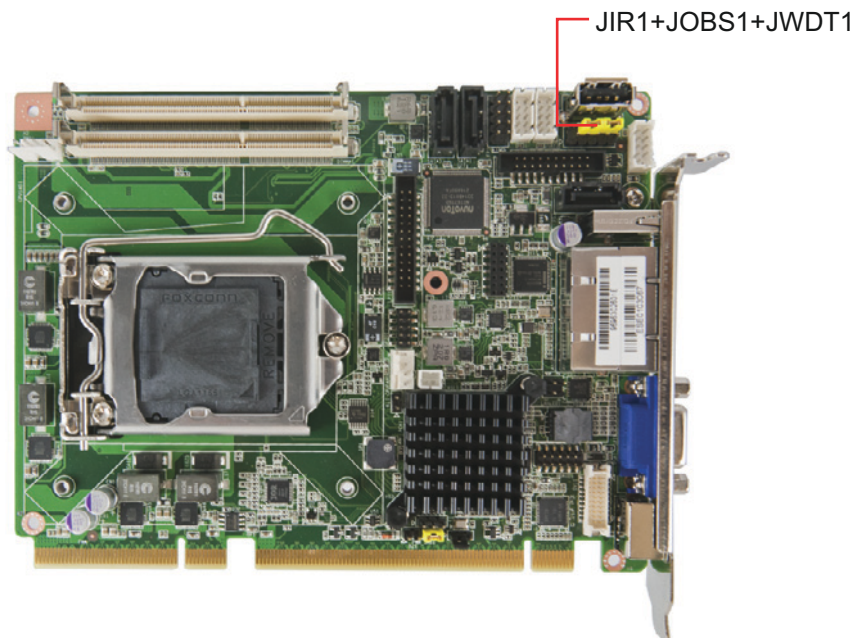

JWDT1			JOBS1	
2	4	6	8	10
○	○	○	○	○
□	○	○	○	○
1	3	5	7	9

JIR1

2.10.1 H/W monitor alarm (JOBS1)

This 2-pin header is for enabling/disabling H/W monitor alarm function.

8-10 Closed: Enables hardware monitor alarm (Default)

8-10 Open: Disables hardware monitor alarm

2.10.2 Watchdog timer (JWDT1)

This is for an setting action trigger on the watchdog timer.

4-6 Close: Enable watchdog timer

4-6 Open: No action

2.10.3 Infrared interface (JIR1)

This is a 5-pin header for an infrared device.

2.11 LAN Ports (LAN1 & LAN2)

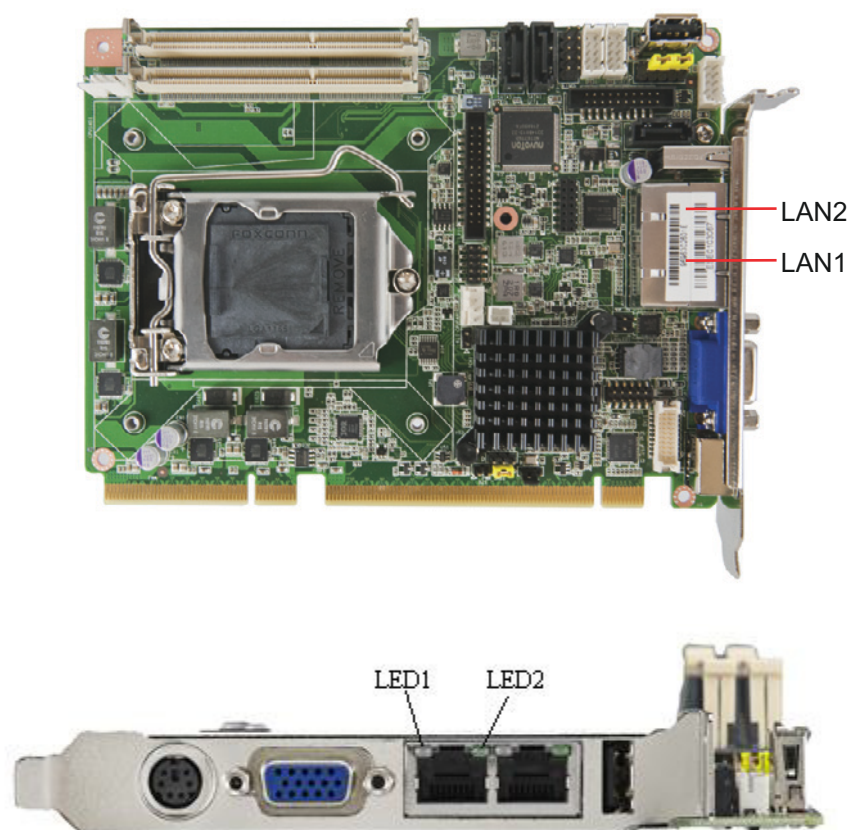

PCE-3026 is equipped with one or two high-performance 1000 Mbps Ethernet LANs. They are supported by all major network operating systems. The RJ-45 jacks on the rear plate provide convenient connectivity.

Table 2.1: LAN LED Indicators

LAN Mode	LED1	LED2
1000Mbps Link On	Green On	On
1000Mbps Active	Green on	Flash
1000Mbps Link Off	Off	Off
100Mbps Link On	Orange On	On
100Mbps Active	Orange On	Flash
100Mbps Link Off	Off	Off
10Mbps Link On	Off	On
10Mbps Active	Off	Flash
10Mbps Link Off	Off	Off

2.12 High Definition Audio Module Interface (HDAUD1)

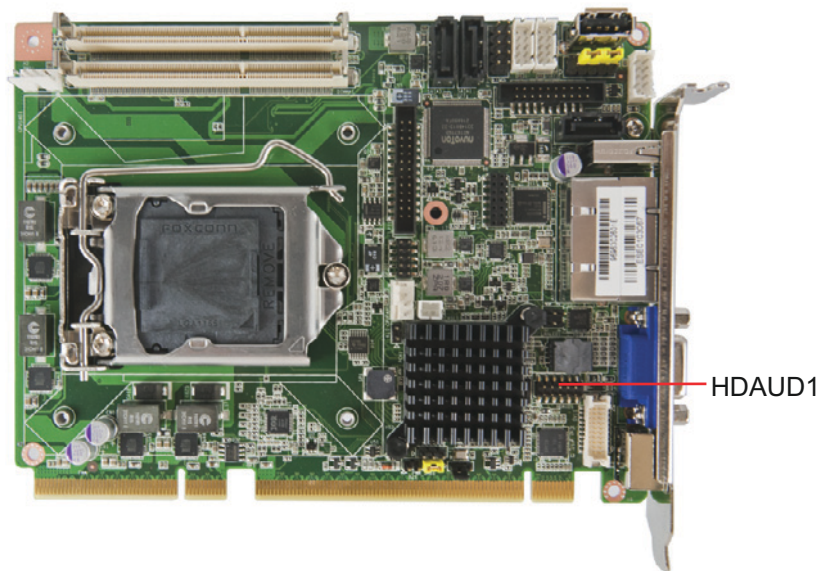

This HDAUD1 pin header is the connection interface to Advantech's 7.1 channel high definition audio module.

Note! Advantech 7.1 channel high definition audio module ordering information.



P/N: PCA-AUDIO-HDA1E

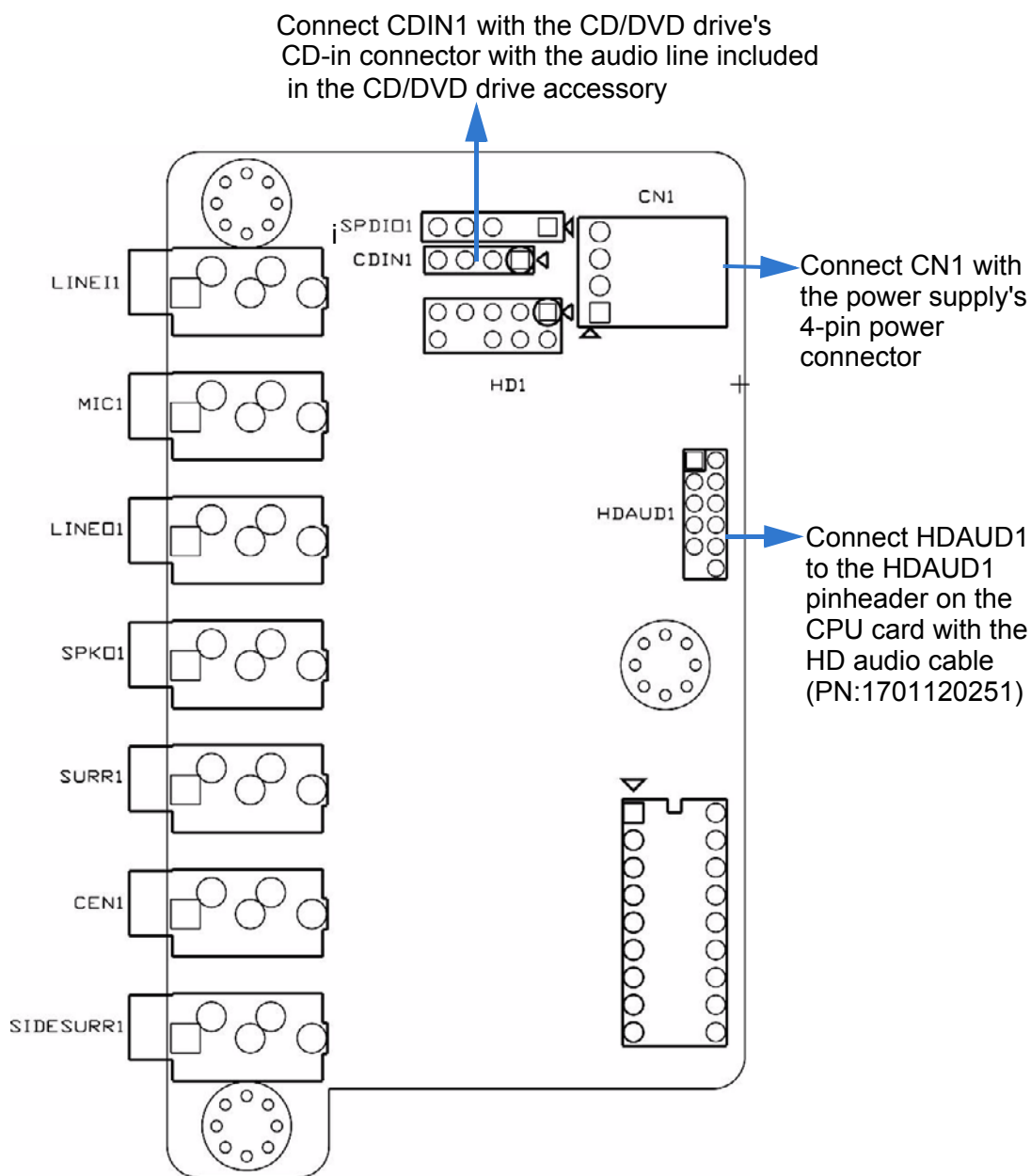
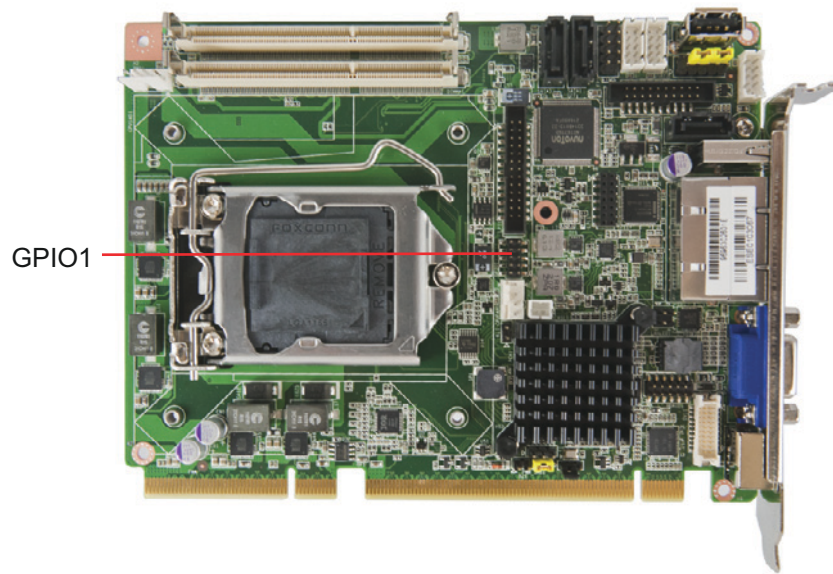

Figure 2.1 Jumper and connector locations of PCA-AUDIO-HDA1E

2.13 GPIO Header (GPIO1)



Provides 10-Pin pin header for 8-bit Digital I/O usage. Refer to Appendix B for detailed information on the pin assignments and programming guide in Appendix C.

2.14 Case Open Connector (JCASE1)

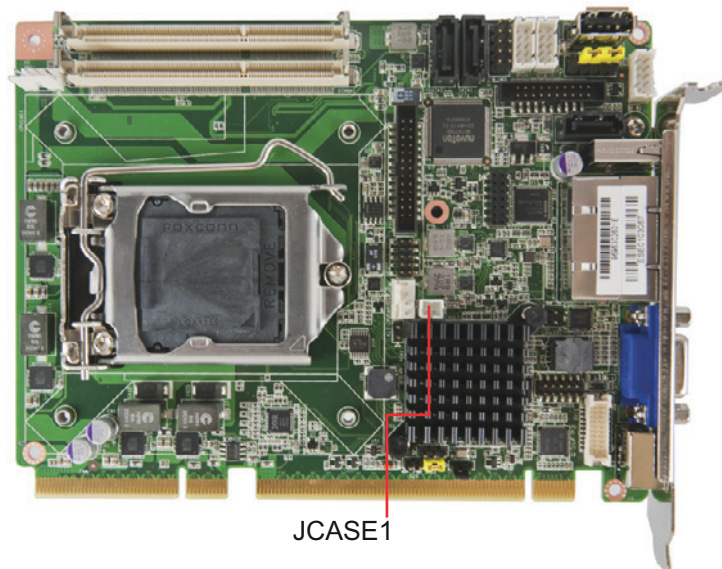

The 2-pin case open connector is for chassis with a case open sensor. When the case is open, the buzzer on motherboard will beep.

2.15 Front Panel LAN Indicator Connector (LANLED1)

Table 2.2: LAN LED Indicators

LAN Mode	LED1	LED2
1000Mbps Link On	Green On	On
1000Mbps Active	Green on	Flash
1000Mbps Link Off	Off	Off
100Mbps Link On	Orange On	On
100Mbps Active	Orange On	Flash
100Mbps Link Off	Off	Off
10Mbps Link On	Off	On
10Mbps Active	Off	Flash
10Mbps Link Off	Off	Off

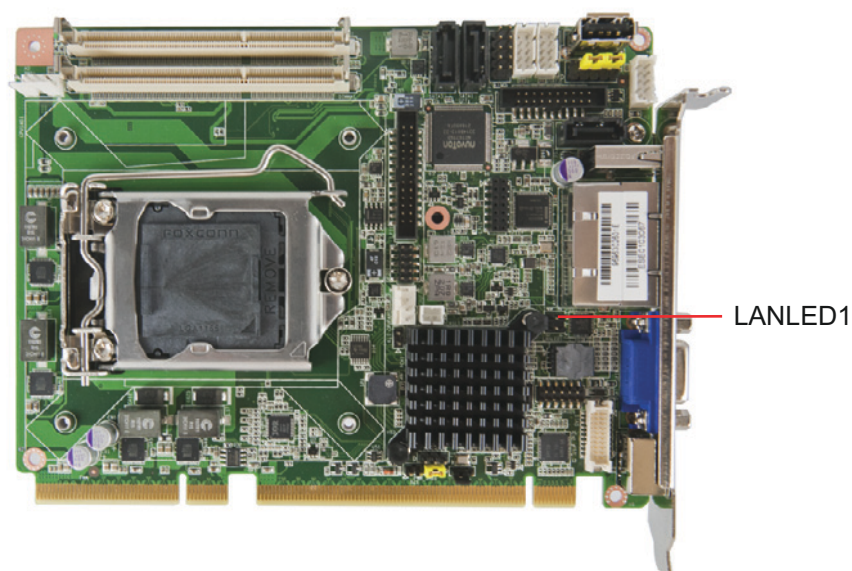

2.16 Serial ATA Interface (SATA1~SATA3)

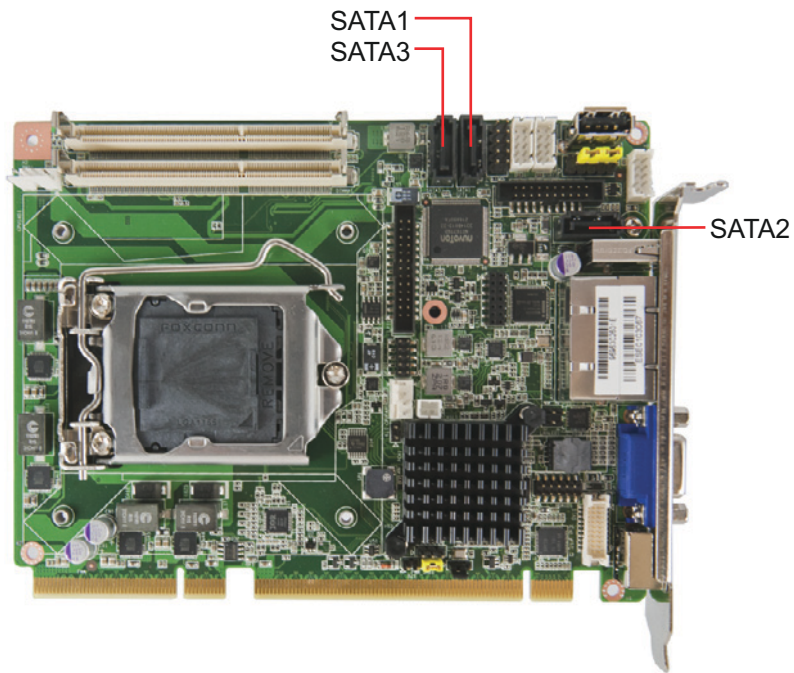

PCE-3026 features high performance serial ATA interface (300MB/s) which eases cabling to hard drivers or CD/DVD drivers with long cables.

2.17 LPC Extension Interface (LPC1)

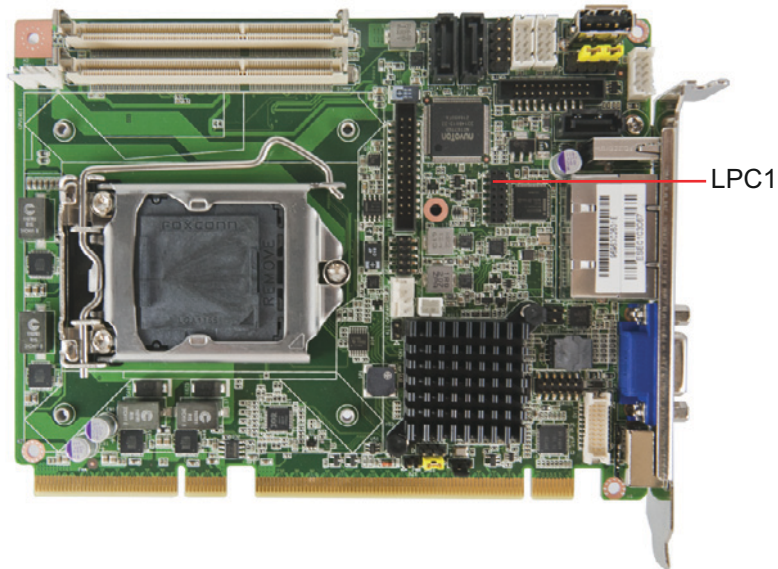

LPC1 is a 14-pin female pinheader for adopting Advantech LPC module, such as PCA-COM232-00A1E, PCA-COM485-00A1E, PCA-TPM-00A1E.

2.18 12/5v power connector (PWR1)

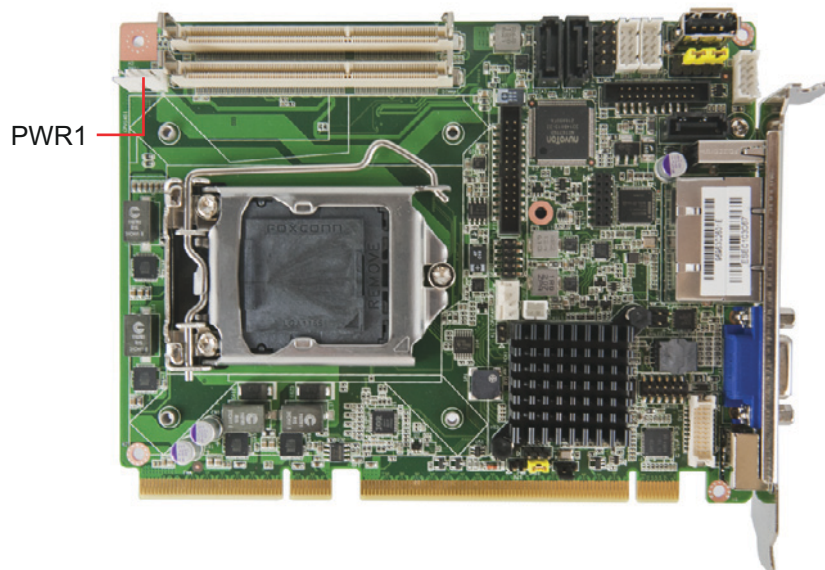

Due to no 5v supply from the golden fingers, please use a power converter: no. 1703040100 to connect from the peripheral power connector on the power supply to PWR1 on board.

Note! Please note that if PWR1 is not connected, PCE-3026 can not be powered on.



Chapter 3

AMI BIOS Setup

3.1 Introduction

With the AMI BIOS Setup program, you can modify BIOS settings and control the special features of your computer. The Setup program uses a number of menus for making changes and turning the special features on or off. This chapter describes the basic navigation of PCE-3026 setup screens.



Figure 3.1 Setup program initial screen

3.2 Entering Setup

Turn on the computer and during POST startup the BIOS setup program can be triggered by pressing "DEL" or "F2" key.

Note! *If the message disappears before you press the "DEL" or "F2" key, please restart the computer and try again.*



3.2.1 Main Setup

When you first enter the BIOS Setup Utility, you will enter the Main setup screen. You can always return to the Main setup screen by selecting the Main tab. There are two Main Setup options. They are described in this section. The Main BIOS Setup screen is shown below.

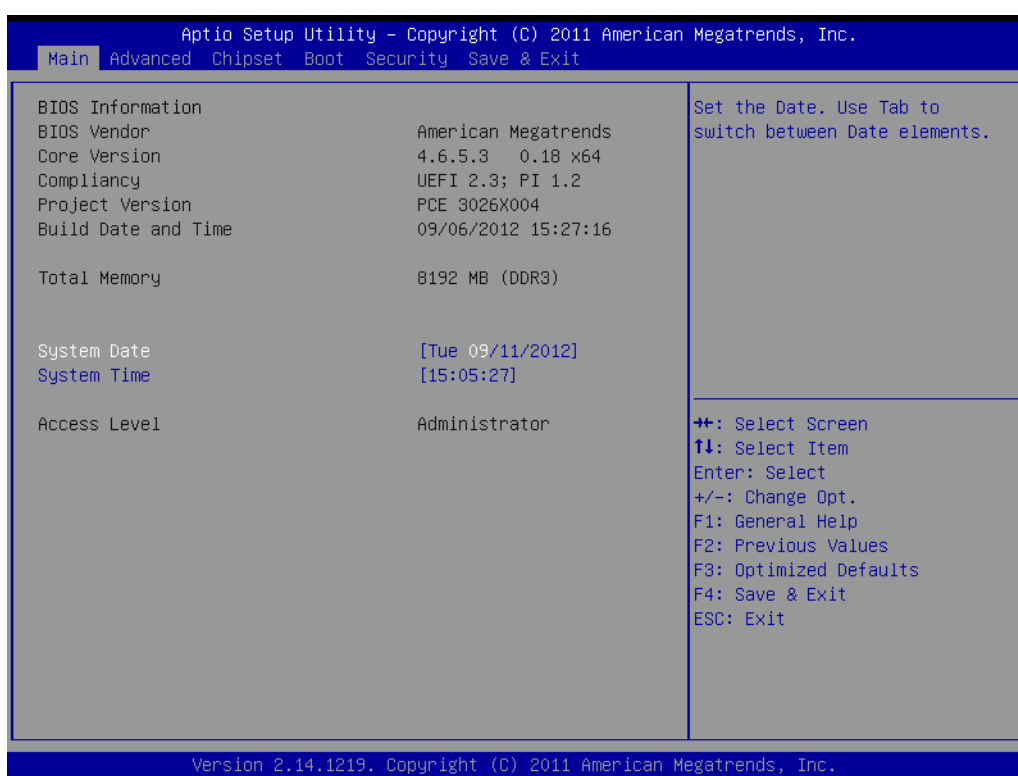

Figure 3.2 Main setup screen

The Main BIOS setup screen has two main frames. The left frame displays all the options that can be configured. Grayed-out options cannot be configured; options in blue can. The right frame displays the key legend.

Above the key legend is an area reserved for a text message. When an option is selected in the left frame, it is highlighted in white. Often a text message will accompany it.

■ System Time / System Date

Use this option to change the system time and date. Highlight System Time or System Date using the <Arrow> keys. Enter new values through the keyboard. Press the <Tab> key or the <Arrow> keys to move between fields. The date must be entered in MM/DD/YY format. The time must be entered in HH:MM:SS format.

3.2.2 Advanced BIOS Features Setup

Select the Advanced tab from PCE-3026 setup screen to enter the Advanced BIOS Setup screen. You can select any of the items in the left frame of the screen, such as CPU Configuration, to go to the sub menu for that item. You can display an Advanced BIOS Setup option by highlighting it using the <Arrow> keys. All Advanced BIOS Setup options are described in this section. The Advanced BIOS Setup screen is shown below, and the sub menus are described on the following pages.

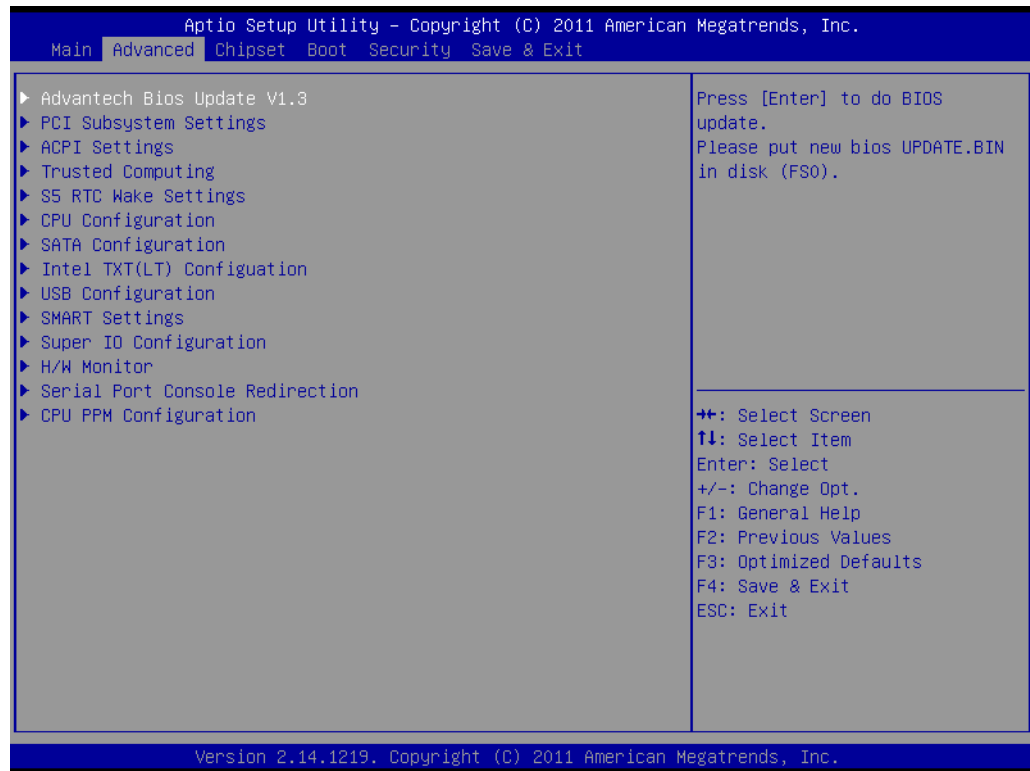

Figure 3.3 Advanced BIOS features setup screen

3.2.2.1 Advantech BIOS Update V1.3

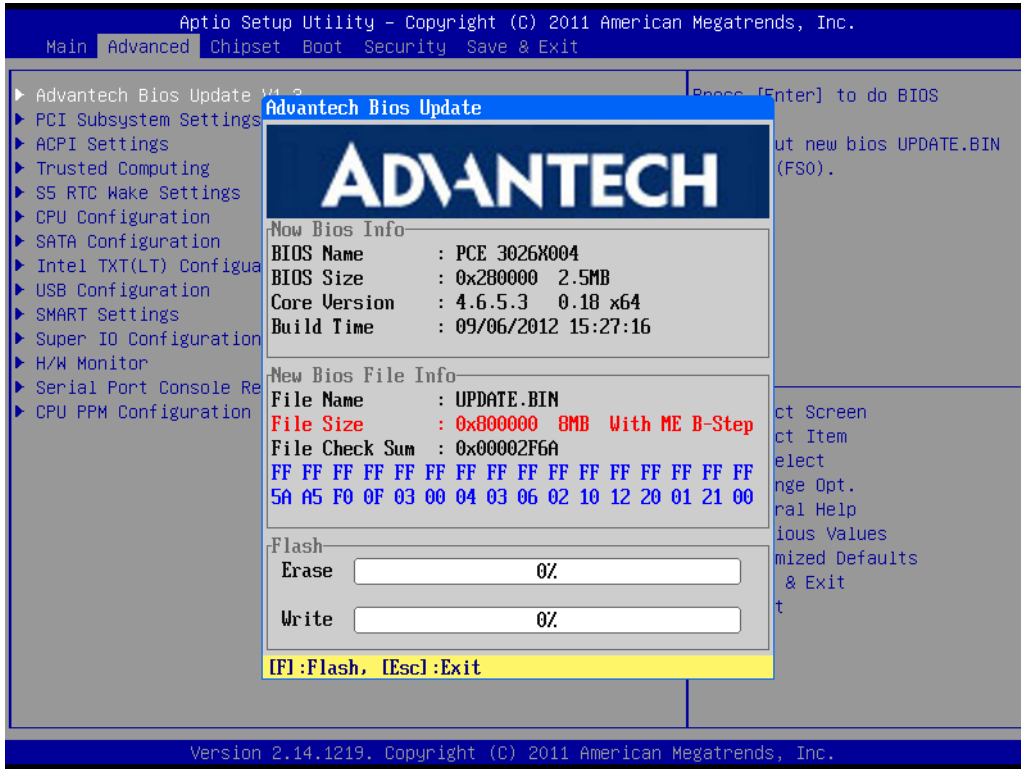

Figure 3.4 Advantech BIOS Update V1.3

You can update the BIOS via a USB storage device in FAT32 format.

3.2.2.2 PCI Subsystem Settings



Figure 3.5 PCI Subsystem Settings

- **PCI 64-bit Resources Handling Above 4G Decoding**

Enable/Disable 64-bit capable devices to be decoded in above 4G address space (only if system supports 64-bit PCI decoding).

- **PCI Common Settings PCI Latency Timer**

Value to be programmed into PCI Latency Timer Register.

- **VGA Palette Snoop**

Enables/Disables VGA palette registers snooping.

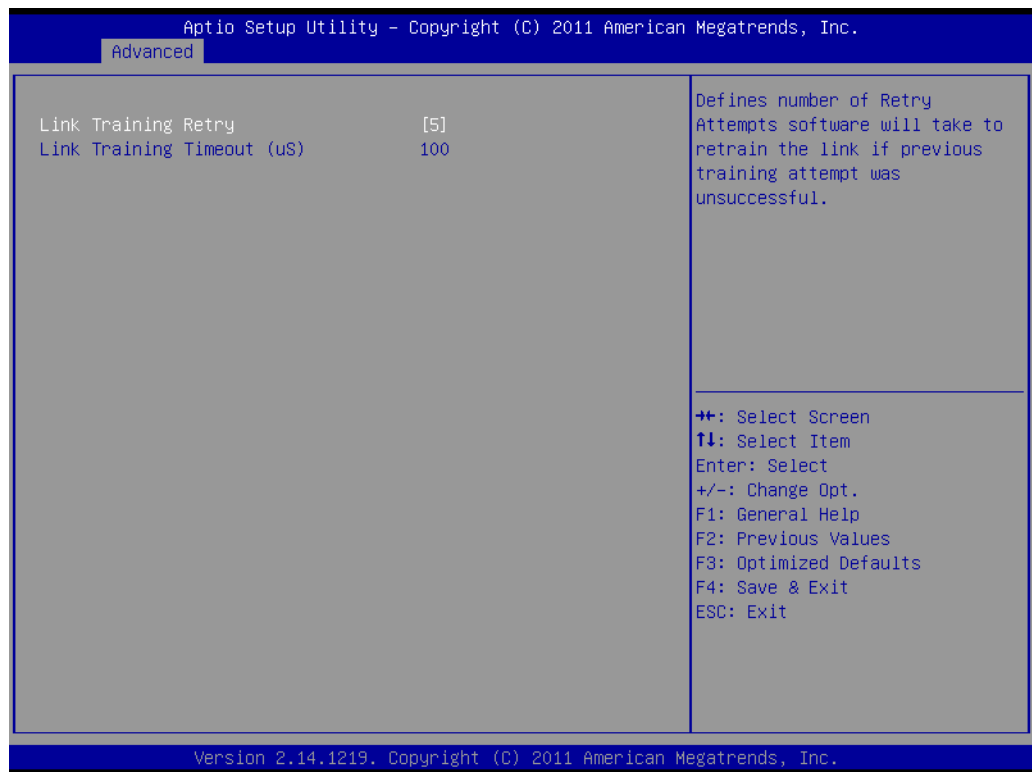

Figure 3.6 PCI Express Settings

- **Link Training Retry**

Defines number of retry attempts the software will take to retrain the link if previous training attempts were unsuccessful.

- **Link Training Timeout**

Defines number of micro-seconds the software will wait before polling "Link Training" bit in the link status register. Values range from 10 to 1000 uS.

3.2.2.3 ACPI Settings

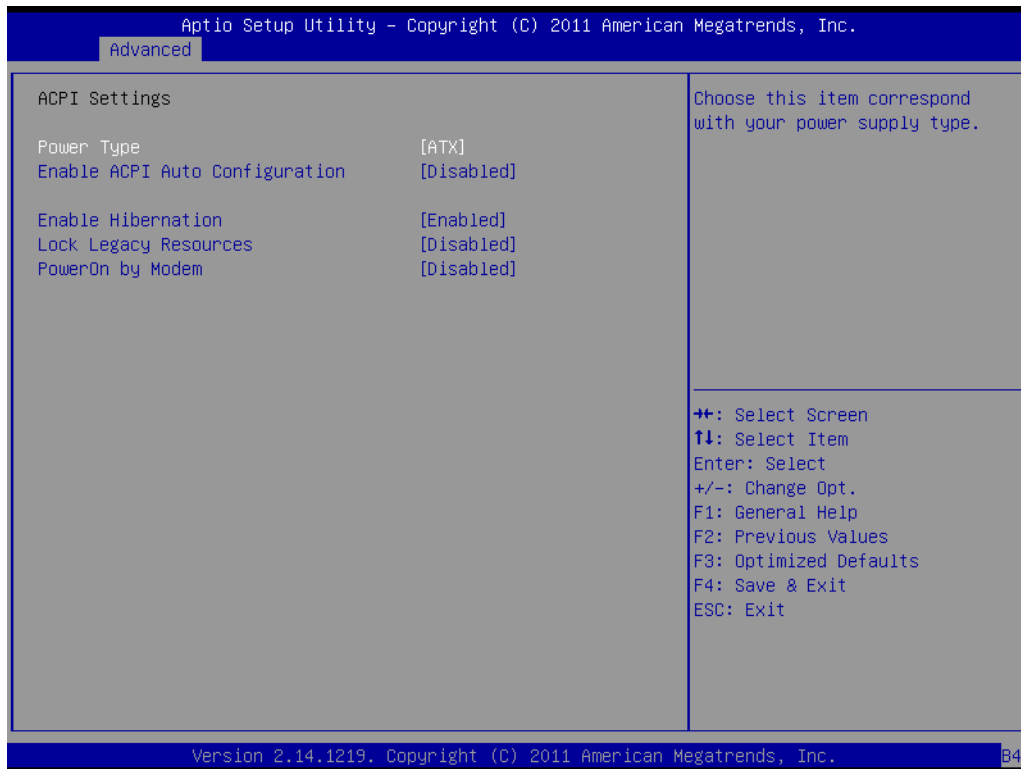

Figure 3.7 ACPI Settings

- **Power Type**
Choose the item that corresponds with your power supply type: ATX or AT.
- **Enable ACPI AUTO configuration**
Enable or disable ACPI auto configuration
- **Enable Hibernation**
"Enable or disable" Hibernate (OS/S4 Sleep State). This option may not be effective with some OS.
- **Lock Legacy Resources**
"Enable" or "Disable" Lock Legacy Resources.
- **PowerOn by Modem**
"Enable" or "Disable" PowerOn by Modem

3.2.2.4 Trust Computing



Figure 3.8 Trust Computing

- **Security Device Support**

Enable or disable BIOS security device support. You can purchase Advantech TPM (Trust Platform Module) PCA-TPM-00A1E for your security device.

3.2.2.5 S5 RTC Wake Setting

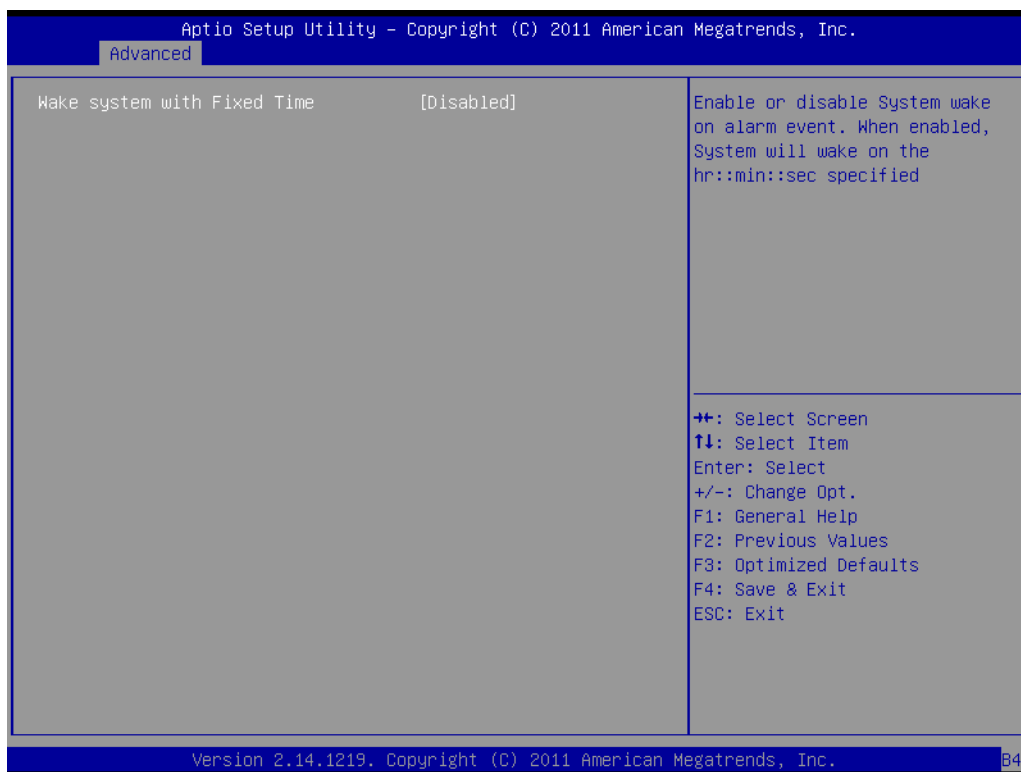

Figure 3.9 S5 RTC configuration

- **Wake System with Fixed Time**

Enable or disable system wake on alarm event, When enabled, the system will wake on the hr:min:sec as specified.

3.2.2.6 CPU Configuration

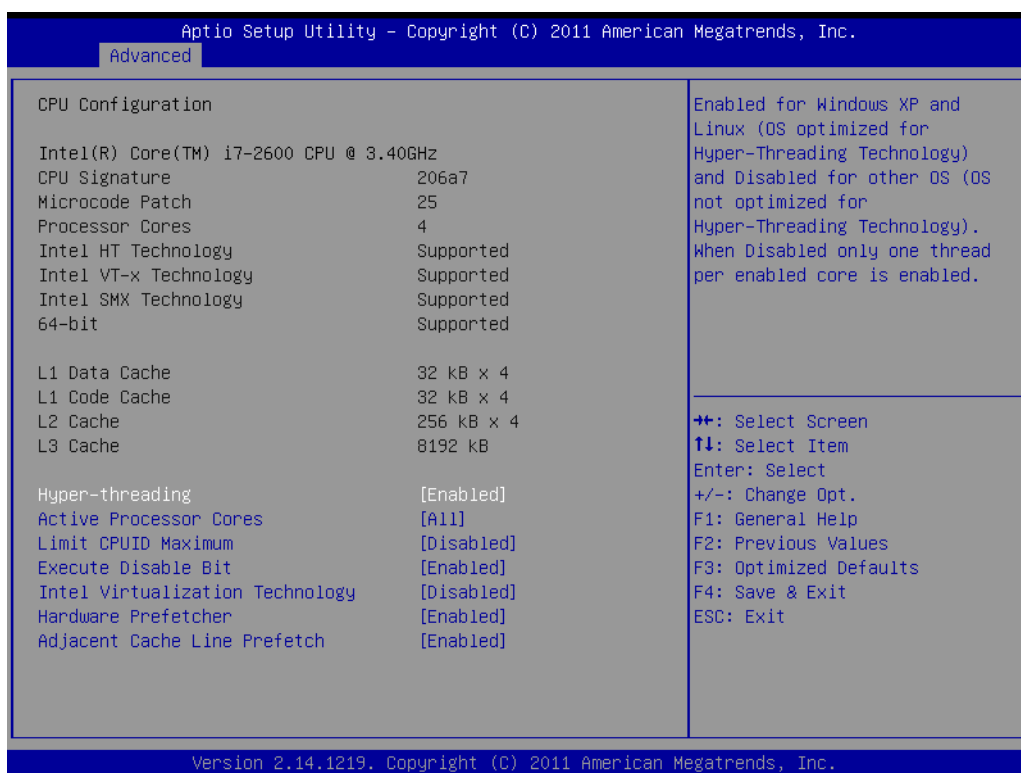

Figure 3.10 CPU Configuration

- **Hyper-threading**
This item allows you to enable or disable Intel hyper-threading technology.
- **Active Processor Core**
Use this to select how many processor cores you want to activate when you are using a dual or quad core processor.
- **Limit CPUID Maximum**
Setting this item to [Enable] allows legacy operating systems to boot even without support for CPUs with extended CPUID functions.
- **Execute Disable Bit**
This item specifies the Execute Disable Bit Feature. The settings are Enabled and Disabled. The Optimal and Fail-Safe default setting is Enabled. If Disabled is selected, the BIOS forces the XD feature flag to always return to 0.
- **Intel Virtualization Technology**
This feature is used to enable or disable the Intel Virtualization Technology (IVT) extension. It allows multiple operating systems to run simultaneously on the same system. It does this by creating virtual machines, each running its own x86 operating system.
- **Hardware Prefetcher**
Hardware Prefetcher is a technique that fetches instructions and/or data from memory into the CPU cache memory well before the CPU needs it, so that it can improve the load-to-use latency. You may choose to enable or disable it.
- **Adjacent Cache Line Prefetch**
The Adjacent Cache-Line Prefetch mechanism, like automatic hardware prefetch, operates without programmer intervention. When enabled through the BIOS, two 64-byte cache lines are fetched into a 128-byte sector, regardless of whether the additional cache line has been requested or not. You may choose to enable or disable it.

3.2.2.7 SATA Configuration

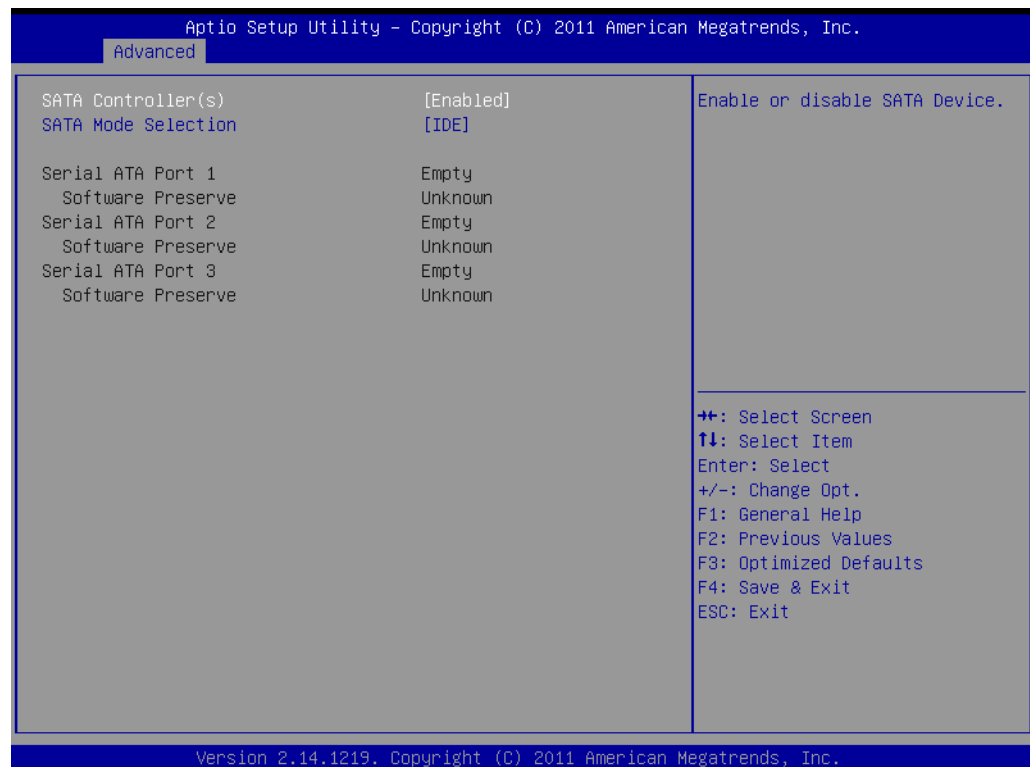

Figure 3.11 SATA Configuration

- **SATA Controller(s)**
Enable or disable SATA Device
- **SATA Mode**
This can be configured as IDE and AHCI.

Note! Some OS request to install under AHCI mode so please consult your local OS vendor for more detailed information.



3.2.2.8 Intel Trusted Execution Technology Configuration



Figure 3.12 Intel Trusted Execution Technology Configuration

- **Intel Trusted Execution Technology Configuration**
This enables or disables Intel® Trusted Execution Technology.

Note! Your hardware platform should support Trust Platform Module (TPM 1.2) to enable Intel Trusted Execution Technology. Please also ensure that Intel VT and Intel VT-d are enabled prior to TXT.



3.2.2.9 USB Configuration

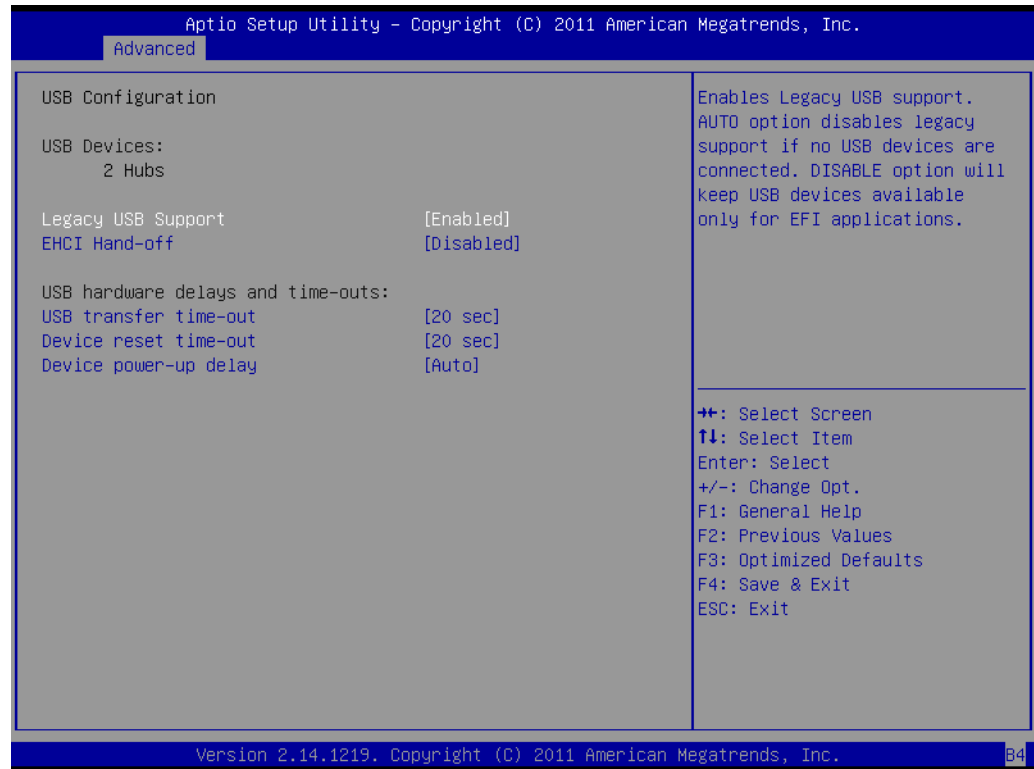

Figure 3.13 USB Configuration

- **Legacy USB Support**

This is for supporting USB devices under legacy OS such as DOS. When choosing "AUTO", the system will automatically detect if any USB device is plugged into the computer. It will automatically enable USB legacy mode when a USB device is plugged in, and disable USB legacy mode when no USB device is plugged in.
- **EHCI Hand-off**

This is a workaround for OS without EHCI hand-off support. The EHCI ownership change should be claimed by EHCI driver.
- **USB transfer time-out**

Allows you to select the USB transfer time-out value. [1,5,10,20 sec]
- **Device reset time-out**

Allows you to select the USB device reset time-out value. [10, 20, 30, 40 sec]
- **Device power-up delay**

Maximum time the device will take before it properly reports itself to the Host Controller. [Auto] uses default value: for a Root port, it is 100 ms, for a Hub port, the delay is taken from Hub descriptor.

3.2.2.10 Smart Setting



Figure 3.14 Smart Setting

- **Smart self test**
Run SMART Self Test on all HDDs during POST.

3.2.2.11 Super IO Configuration

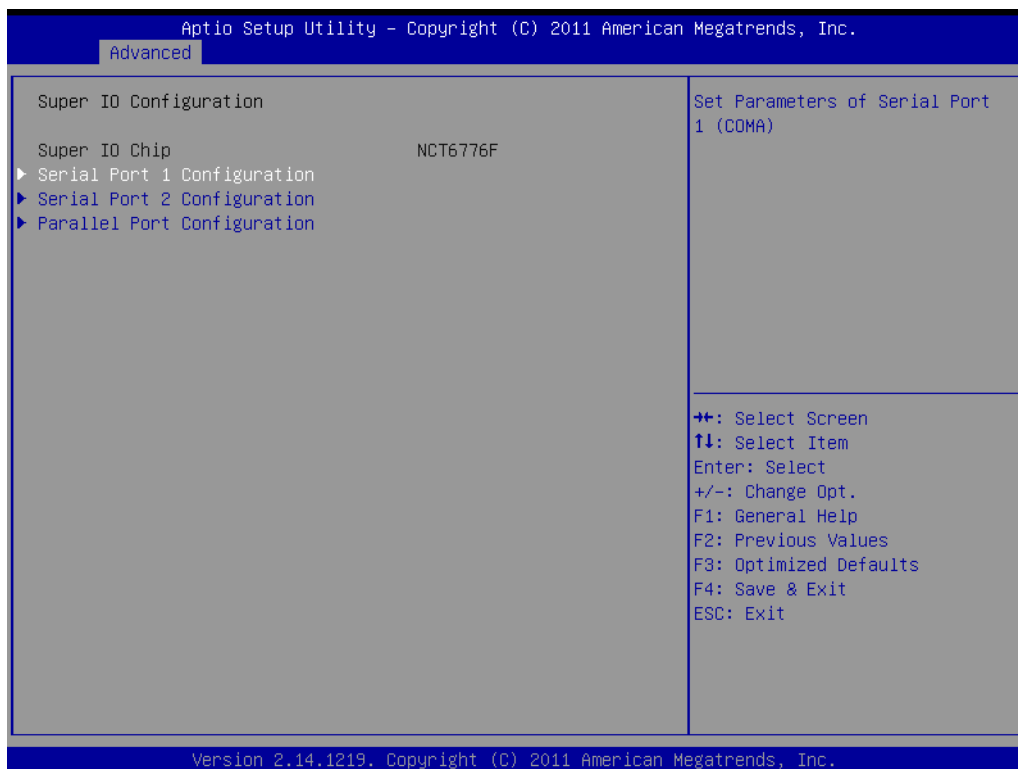

Figure 3.15 Super IO Configuration

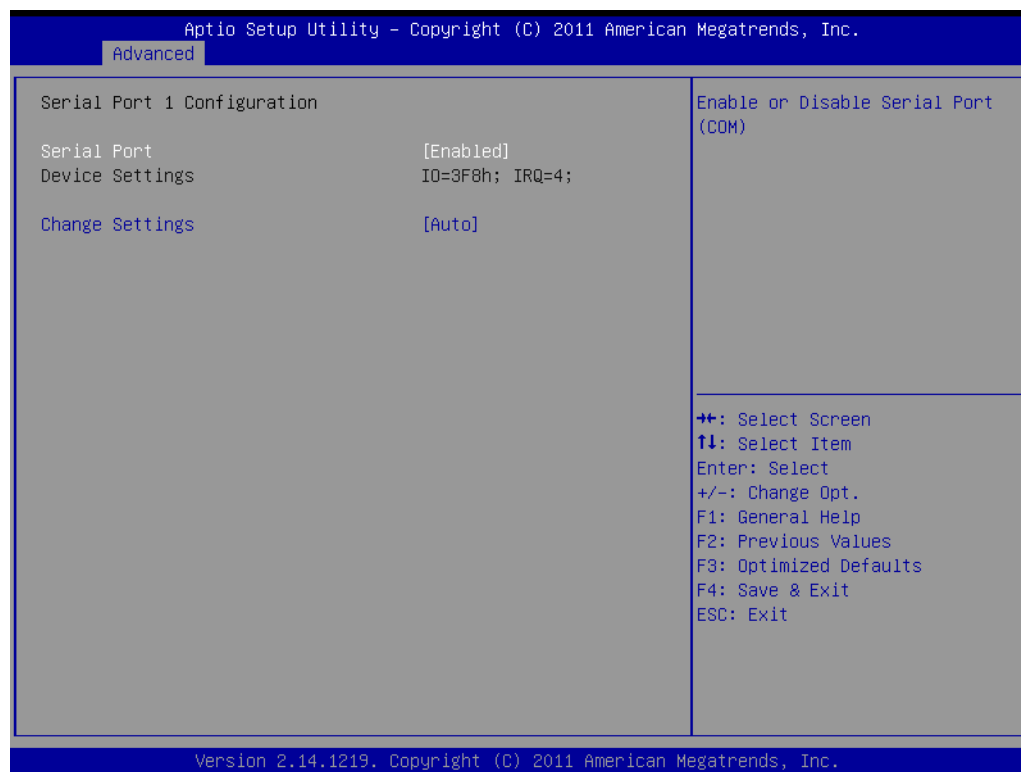

Figure 3.16 Serial Port 1 Configuration

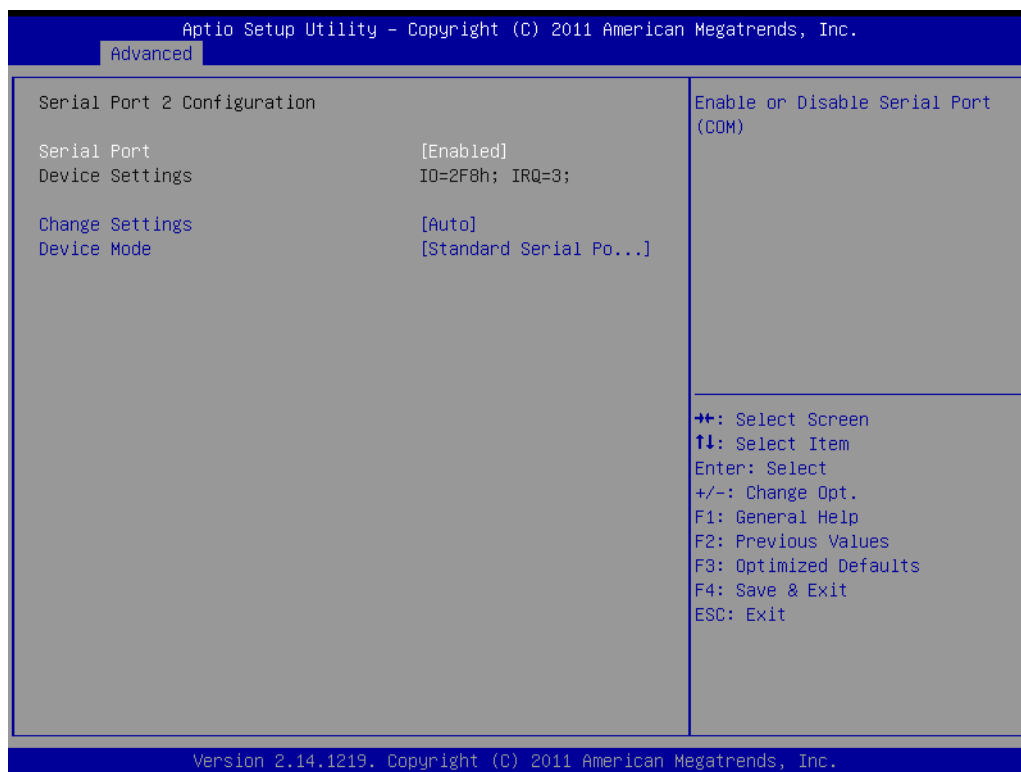

Figure 3.17 Serial Port 2 Configuration



Figure 3.18 Parallel Configuration

- **Serial Port 1 -2 configuration**
“Enable or Disable” Serial Port.
- **Change settings**
Select optimal settings for serial port 1 &2
- **Device mode**
Serial port 2 could be selected as [Standard Serial Port Mode], [IrDA 1.0 (HP SIR) Mode], or [ASKIR Mode].
- **Parallel Port configuration**
“Enable or Disable” Parallel Port.
- **Change settings**
Selected the optimal settings for printer port.
- **Device Mode**
Change the printer port mode.

3.2.2.12 H/W Monitor

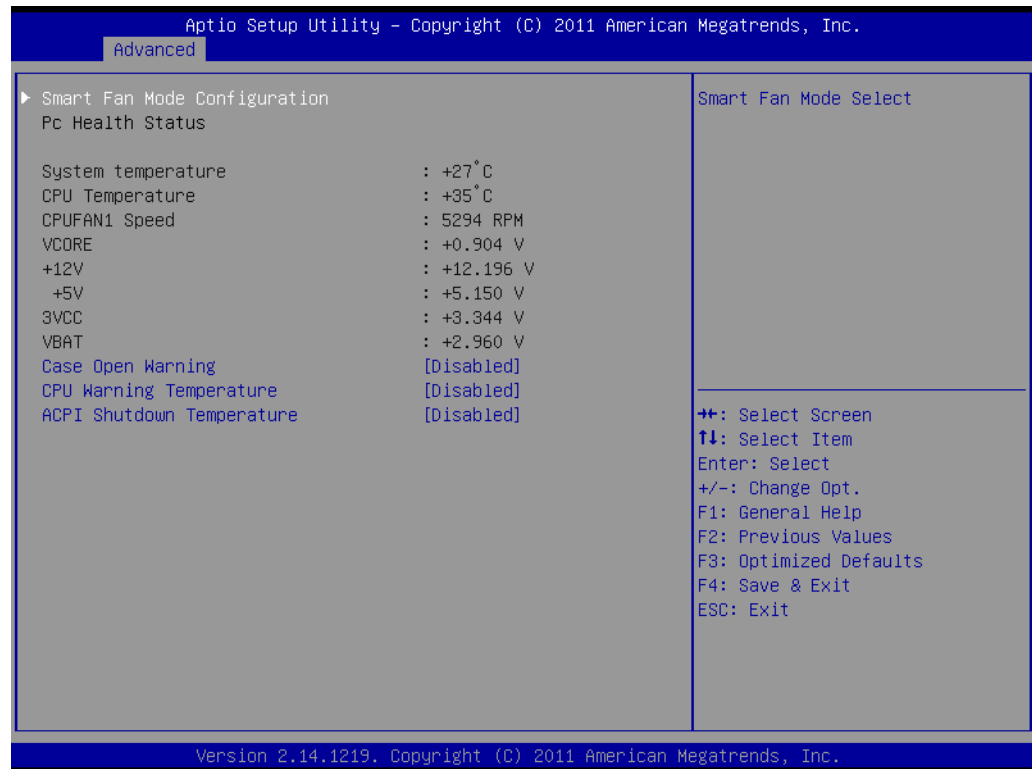

Figure 3.19 PC Health Status

- **Smart Fan Mode Configuration**
Enable or disable Smart fan
- **Case Open Warning**
Enable/Disable the Chassis Intrusion monitoring function. When enabled and the case is opened, the speaker beeps.
- **CPU Warning Temperature**
Use this to set the CPU warning temperature threshold. When the system reaches the warning temperature, the speaker will beep.
- **ACPI Shutdown Temperature**
Use this to set the ACPI shutdown temperature threshold. When the system reaches the shutdown temperature, it will be automatically shut down by ACPI OS to protect the system from overheating damage.

3.2.2.13 CPU PPM Configuration

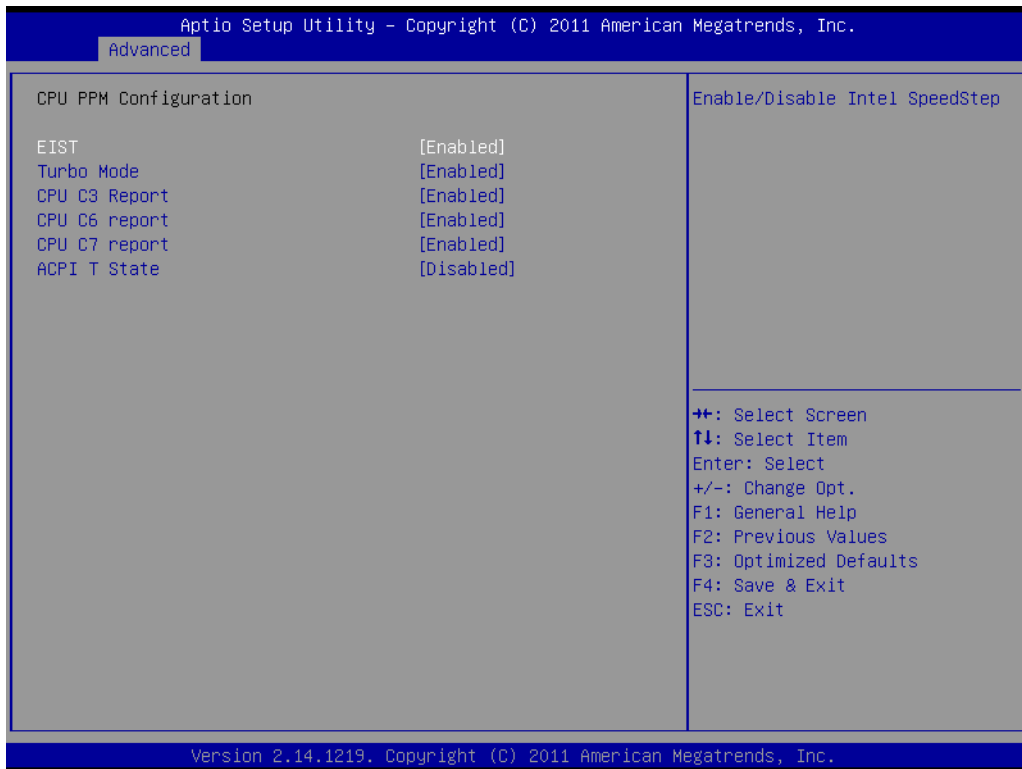
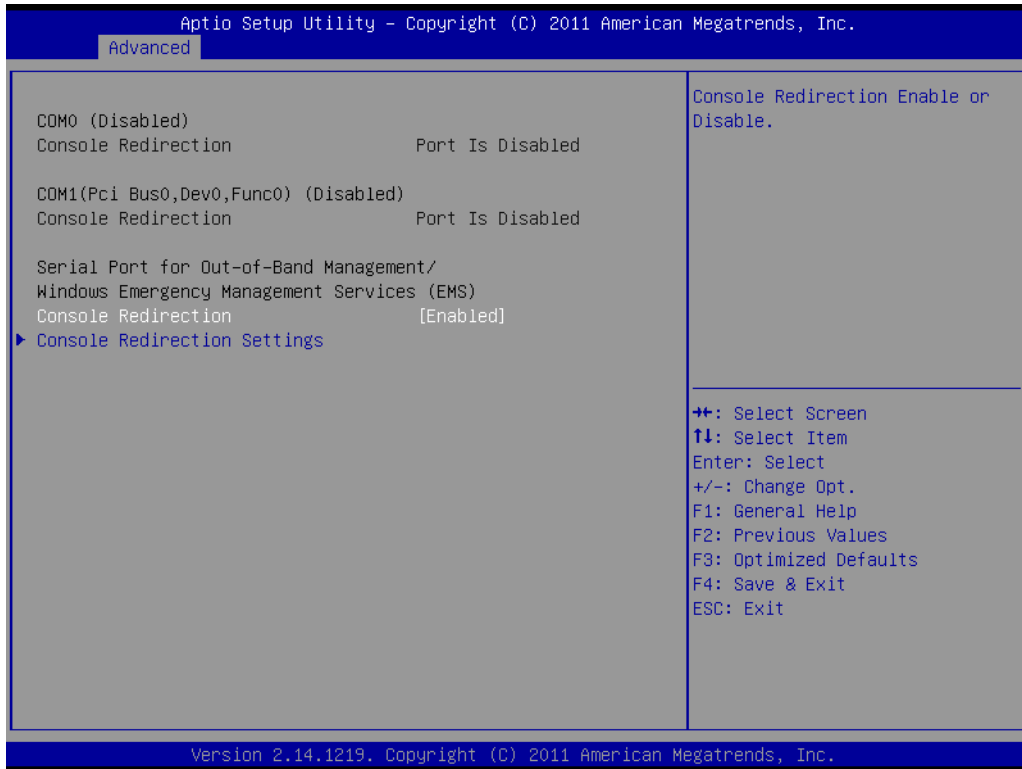

Figure 3.20 CPU PPM Configuration

- **EIST**
Enable/Disable Intel Speedstep.
- **Turbo mode**
Enable or disable turbo mode.
- **CPU C3 report**
Enable/Disable CPU C3 (ACPI C2) report to OS.
- **CPU C6 report**
Enable/Disable CPU C6 (ACPI C2) report to OS.
- **CPU C7 report**
Enable/Disable CPU C7 (ACPI C2) report to OS.
- **ACPI T state**
Enable/Disable ACPI T state support.

3.2.3 Chipset

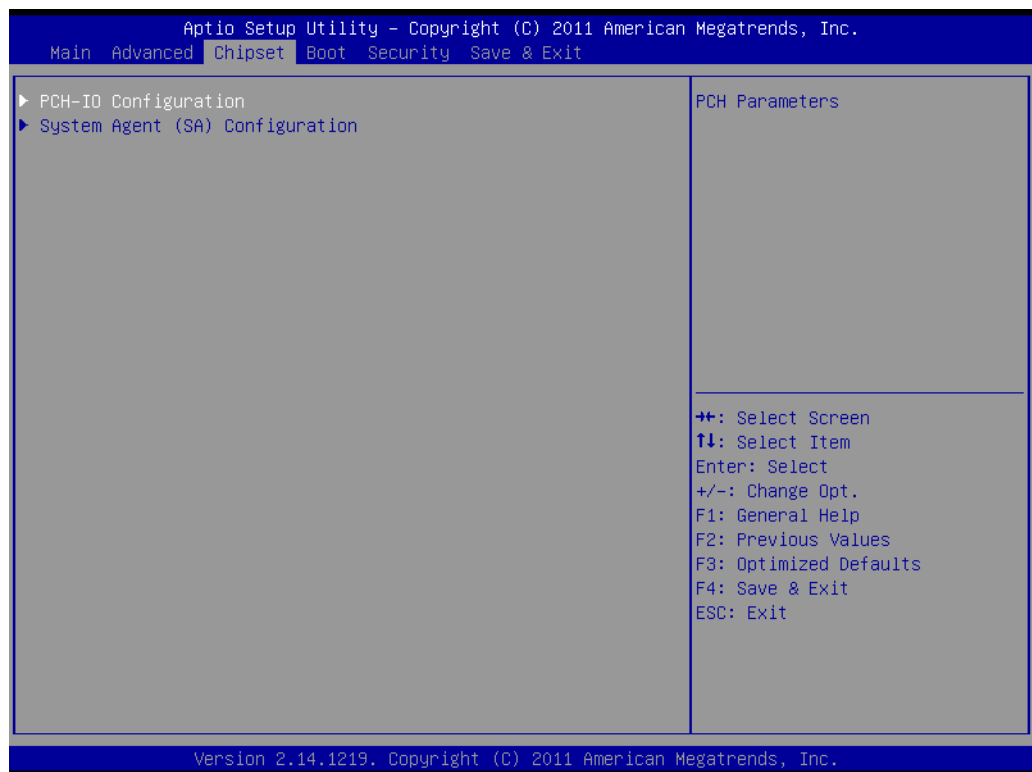

Figure 3.21 Chipset

3.2.3.1 PCH-IO Configuration

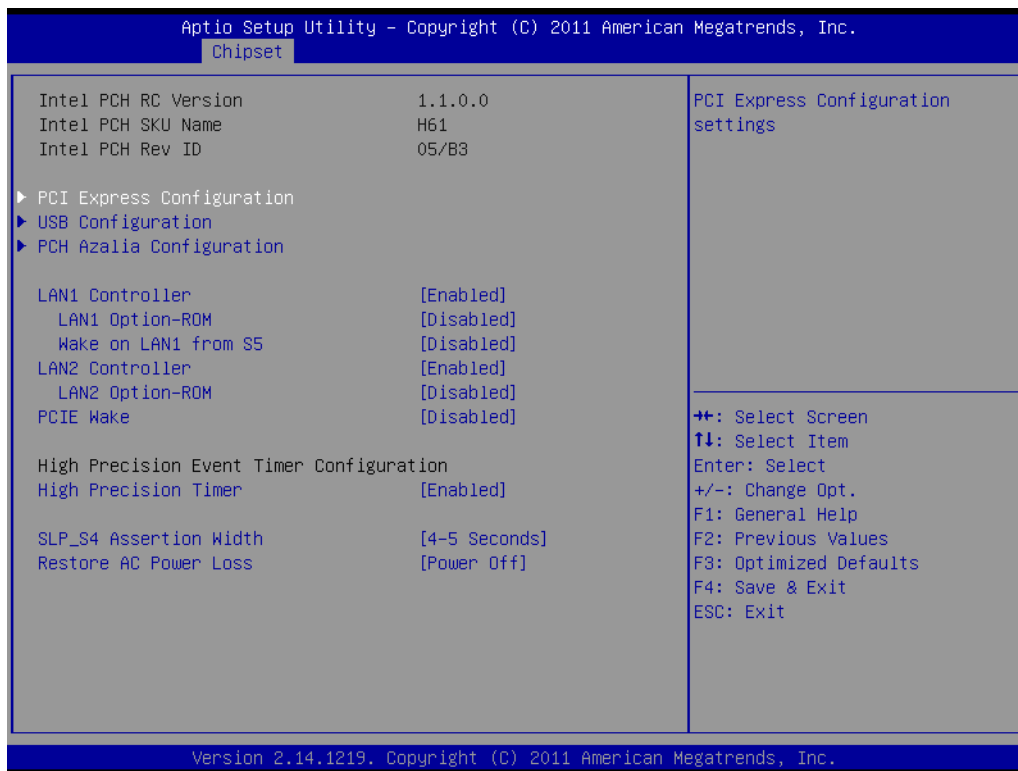

Figure 3.22 PCH IO Configuration

3.2.3.1.1 PCI Express Configuration

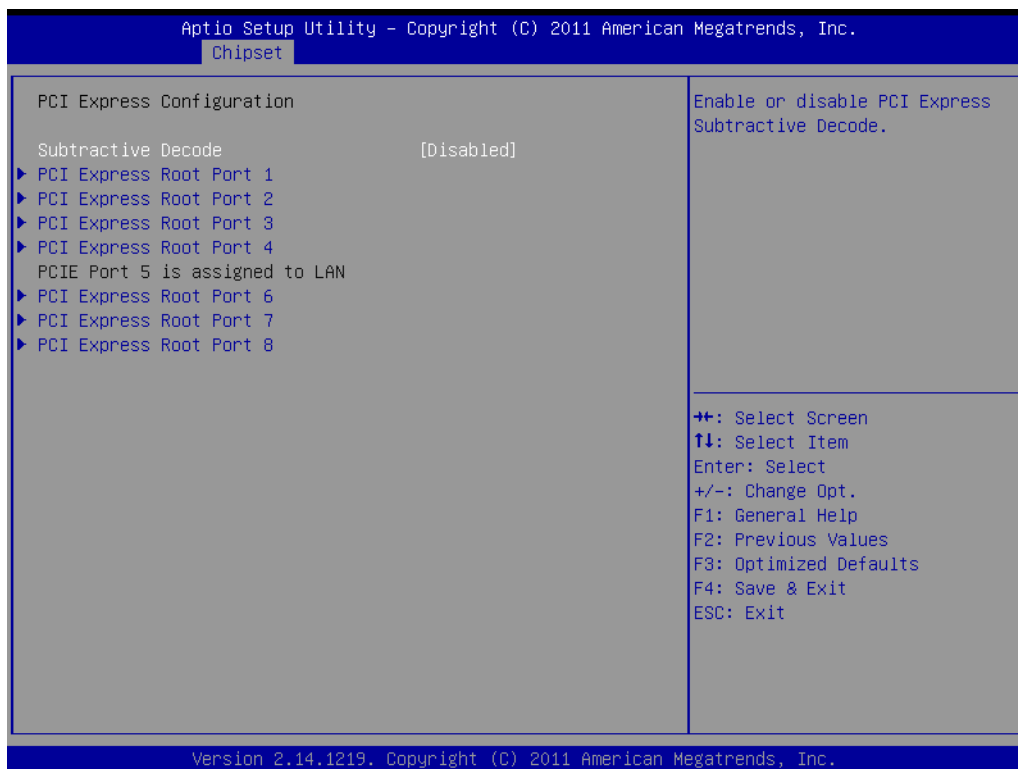

Figure 3.23 PCI Express Configuration

- **Subtractive decode**
Enable or disable PCI Express subtractive decode.
- **PCI Express Configuration**
PCI Express Root Port 1 to 8 Setting.

3.2.3.1.2 USB Configuration

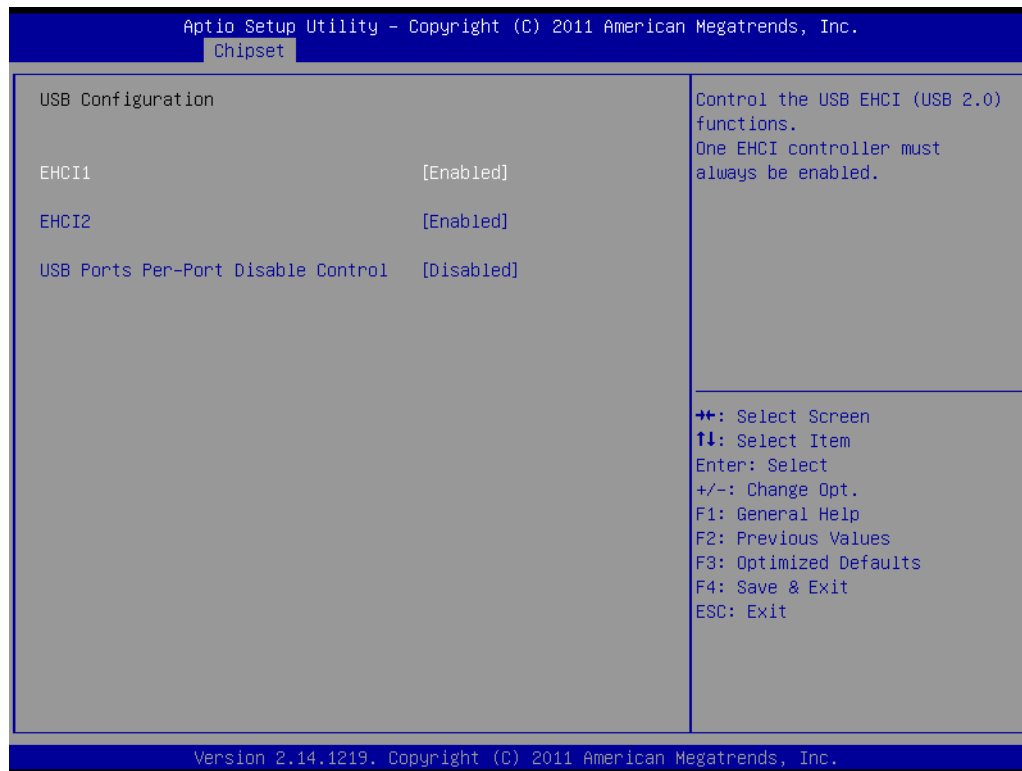

Figure 3.24 USB Configuration

- **EHCI1**
Control the USB EHCI (USB2.0) functions. One EHCI controller must always be enabled.
- **EHCI2**
Control the USB EHCI(USB2.0) functions. One EHCI controller must always be enabled.
- **USB Ports Pre-port Disable Control**
Control each of the USB ports (0-13) disabling.

3.2.3.1.3 PCH Azalia Configuration

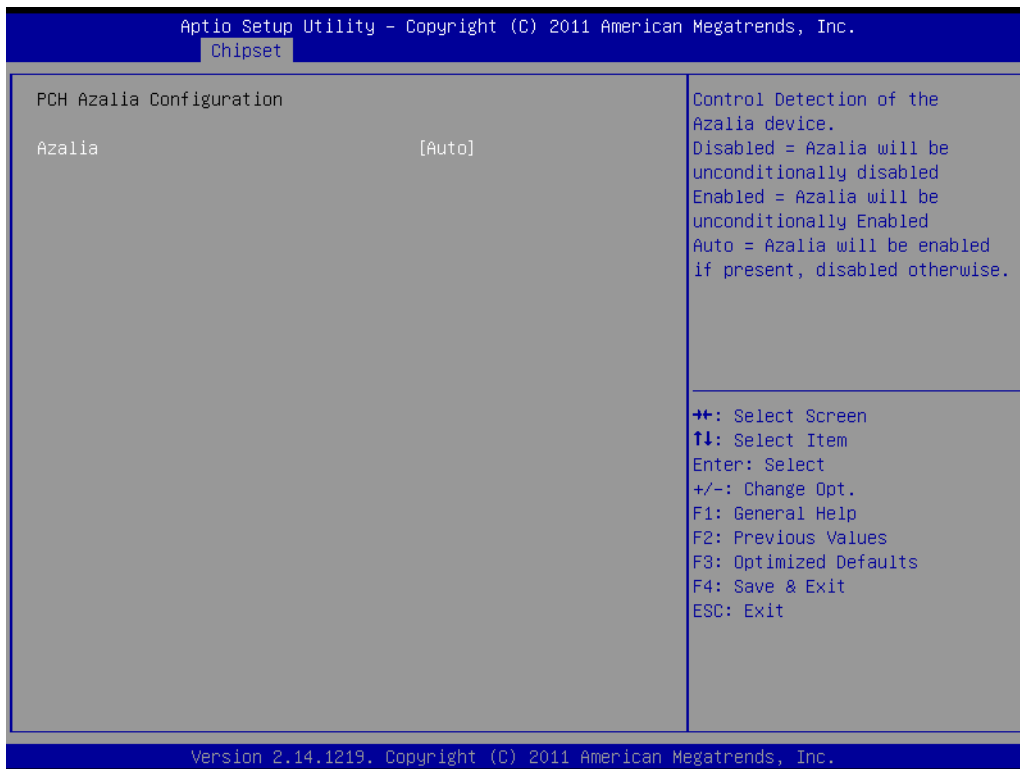

Figure 3.25 PCH Azalia Configuration

- **Azalia**
Control detection of the Azalia device.
Disable=Azalia will be unconditionally disabled
Enable=Azalia will be unconditionally enabled
Auto=Azalia will be enabled if present, disabled otherwise.
- **LAN1 Controller**
Enable or Disable LAN1 Controller.
- **LAN 1 Option-ROM**
Enable or Disable LAN 1 boot option for legacy network devices.
- **Wake on LAN1 from S5**
Enable or Disable LAN1 to wake the system. (The wake on LAN cannot be disabled if ME is on at Sx state).
- **LAN2 Controller**
Enable or Disable LAN2 Controller.
- **LAN 2 Option-ROM**
Enable or Disable LAN 2 boot option for legacy network devices.
- **PCIE Wake**
Enable or Disable PCIE to wake the system from S5.
- **High precision Timer**
Enable or Disable high precision event timer.
- **SLP_S4 Assertion Width**
Select a minimum assertion width of the SLP_S4# signal.
- **Restore AC Power Loss**
Power Off, power On or Last State to restore AC power loss

3.2.3.2 System Agent (SA) Configuration

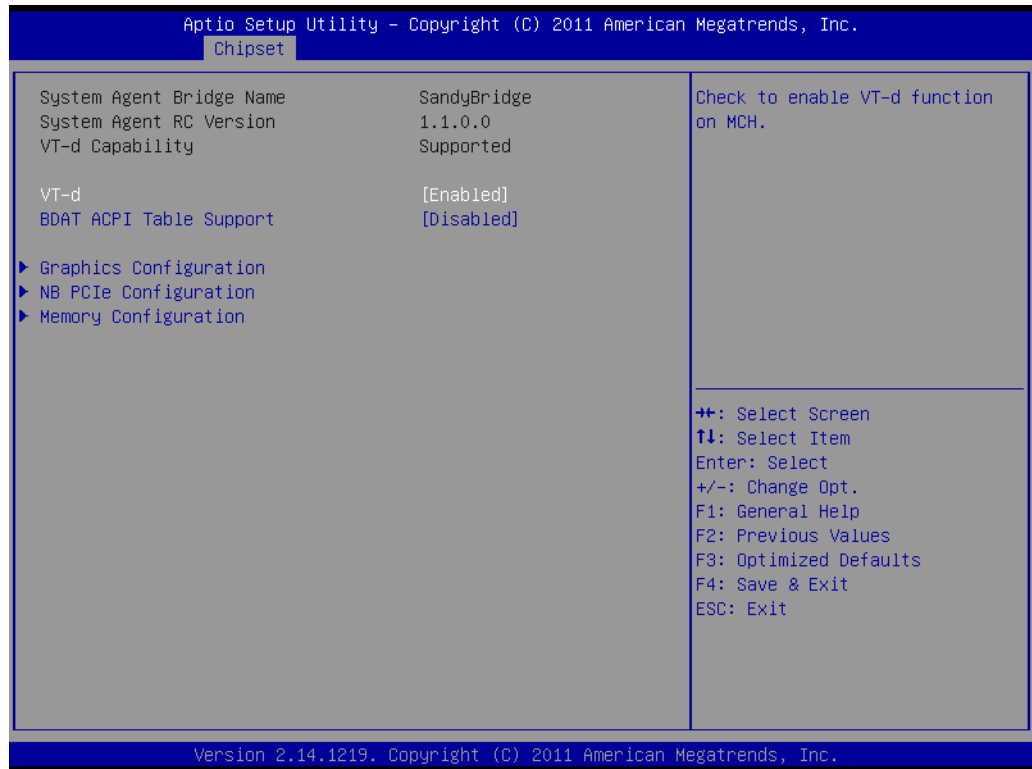

Figure 3.26 System Agent (SA) Configuration

- **VT-d**
Check to enable VT-d function on MCH.
- **BDAT ACPI Table support**
Enable support for the BDAT ACPI table.

3.2.3.3 Graphics Configuration

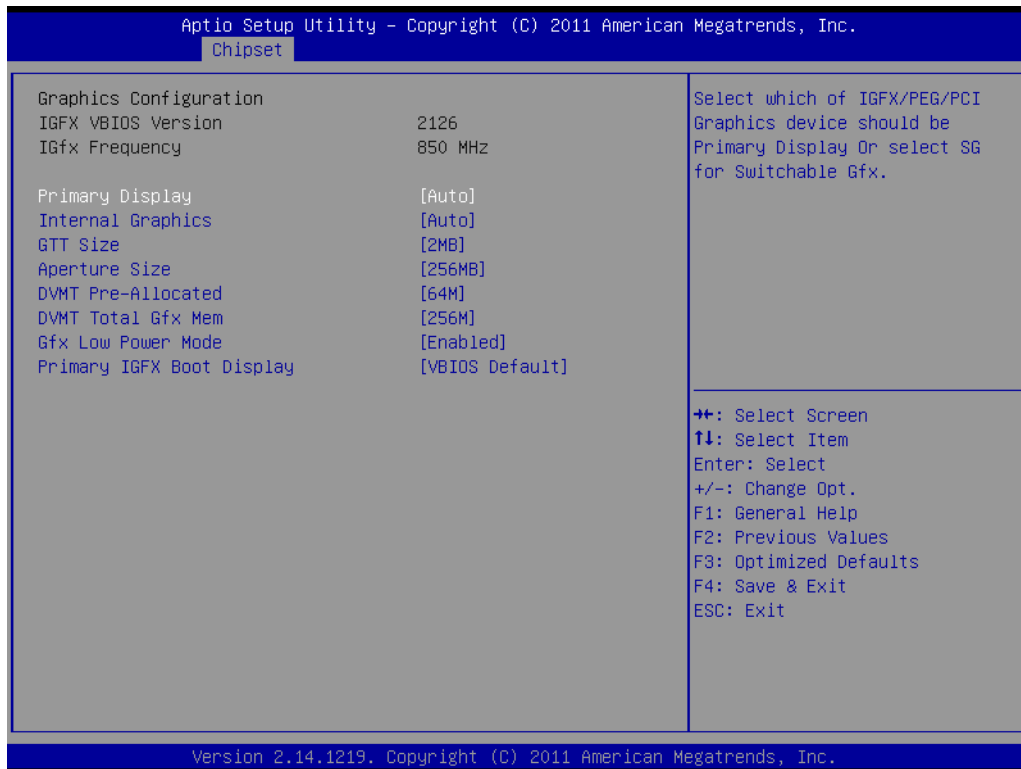

Figure 3.27 Graphics Configuration

- **Primary Display**
Select which IGFX/PEG/PCI graphics device should be primary display or select SG for switchable GFX.
- **Internal Graphics**
Keep IGD enabled based on the setup options.
- **GTT Size**
Select the GTT size.
- **Aperture Size**
Select the aperture size.
- **DVMT Pre-Allocated**
Select DVMT5.0 pre-allocated (fixed) graphics memory size, up to 1024 M, used by the internal graphics device.
- **DVMT Total Gfx Mem**
Select 128 M, 256 M or MAX DVMT5.0 total graphics memory size used by the internal graphics device.
- **Gfx Low Power Mode**
This option is applicable for SFF only.
- **Primary IGFX Display**
Select the video device which will be activated during POST. This has no effect if external graphics are present. Secondary boot display selection will appear based on your selection. VGA modes will be supported only on primary display. Note: In DOS mode, only either VGA or DVI single output are supported.

3.2.3.4 NB PCIe Configuration

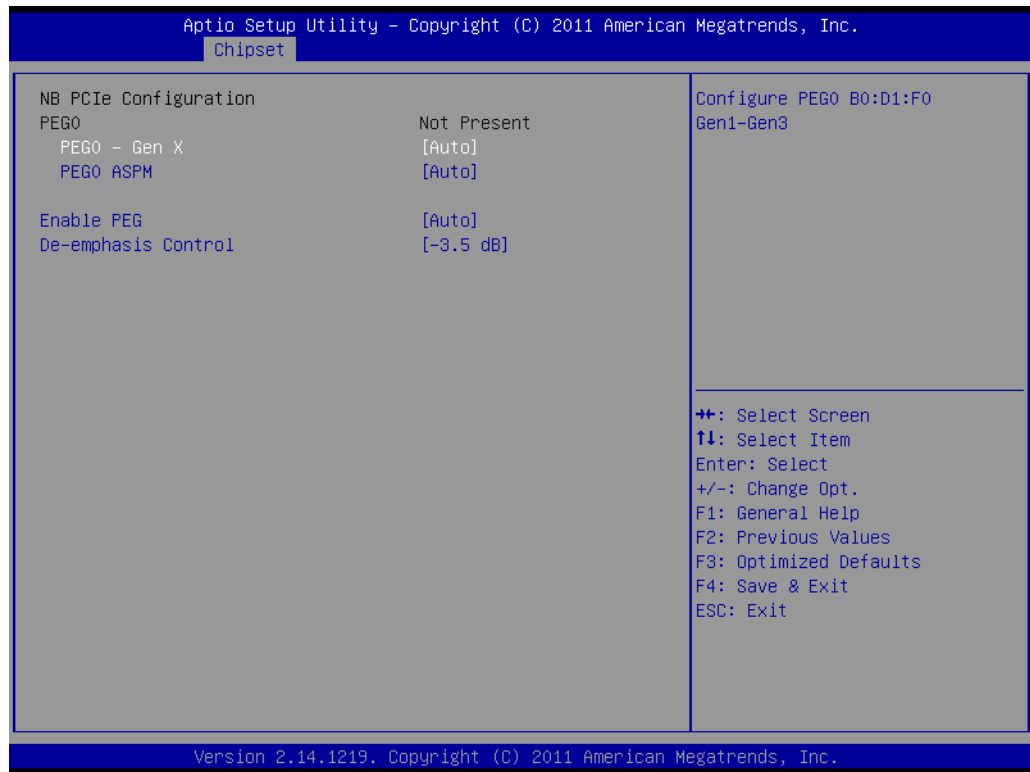

Figure 3.28 NB PCIe Configuration

- **PEG0-Gen X**
Configure auto, Gne1, Gen2, or Gen 3.
- **PEG0 ASPM**
Control ASPM support for the PEG: Device 1 Function 0. This has no effect if PEG is not the currently active device.
- **Enable PEG**
Enable/Disable/Auto the PEG.
- **De-emphasis Control**
Configure the De-emphasis control on PEG.

3.2.3.5 Memory Configuration

Overview memory detail information.

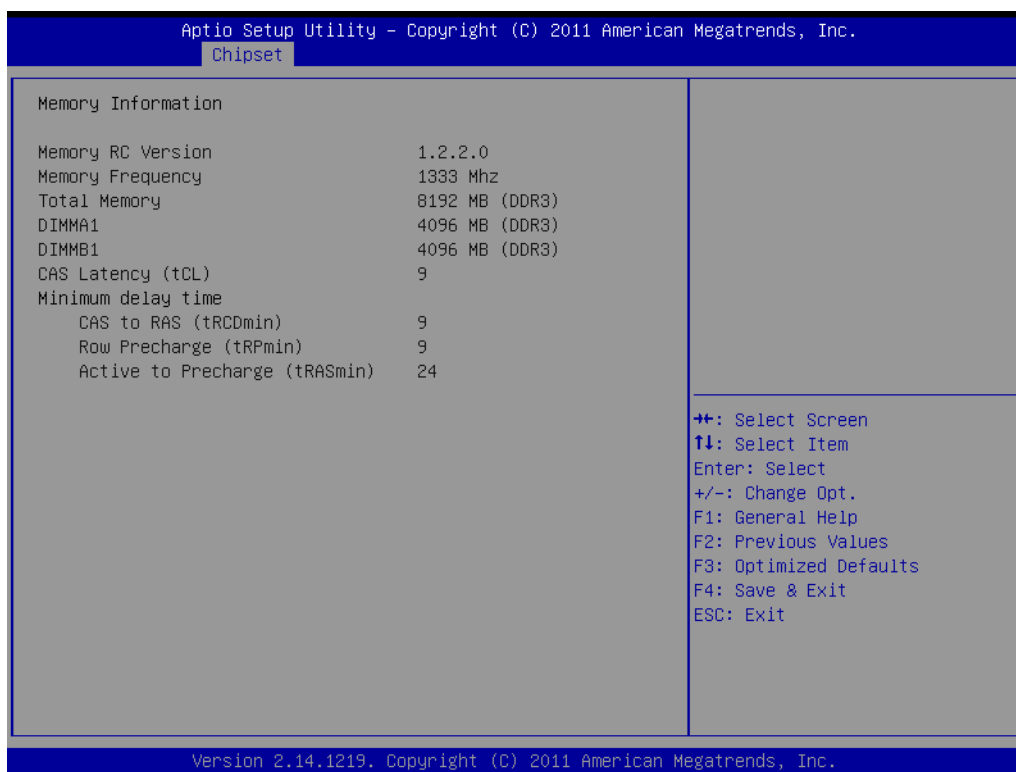

Figure 3.29 Memory Information

3.2.4 Boot

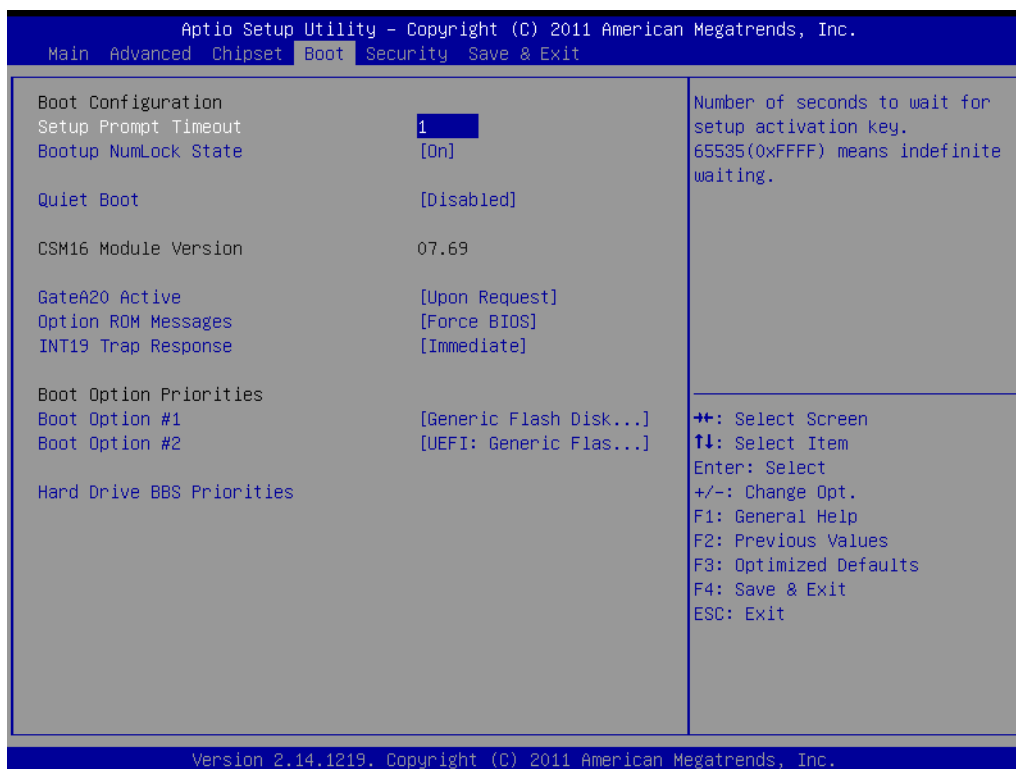

Figure 3.30 Boot

- **Setup Prompt timeout**
Number of seconds to wait for setup activation key.
- **Startup NumLock State**
Select the keyboard Numlock state.
- **Quiet Boot**
Enable/Disable Quiet Boot option.
- **GateA20 Active**
Upon request-GA20 can be disabled using BIOS services.
Always-do not allow disabling GA20; this option is useful when any RT code is executed above 1 MB.
- **Option Rom Messages**
Set display mode for option ROM.
- **INT19 Trap Response**
BIOS reaction on INT19 trapping by option ROM:
IMMEDIATE-execute the trap right away.
POSTPONED-execute the trap during legacy boot.
- **Boot Option Priorities**
you can see the information of boot priority option of devices.

3.2.5 Security

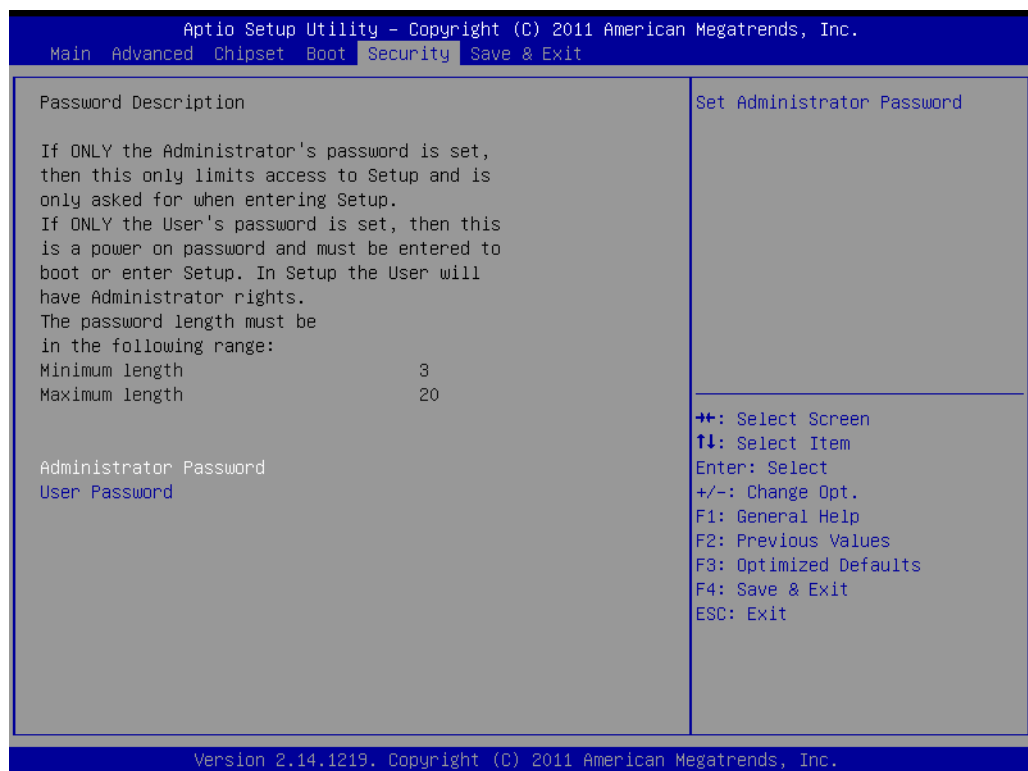

Figure 3.31 Security

Select Security Setup from PCE-3026 Setup main BIOS setup menu. All Security Setup options, such as password protection and virus protection are described in this section. To access the sub menu for the following items, select the item and press <Enter>

3.2.6 Save & Exit

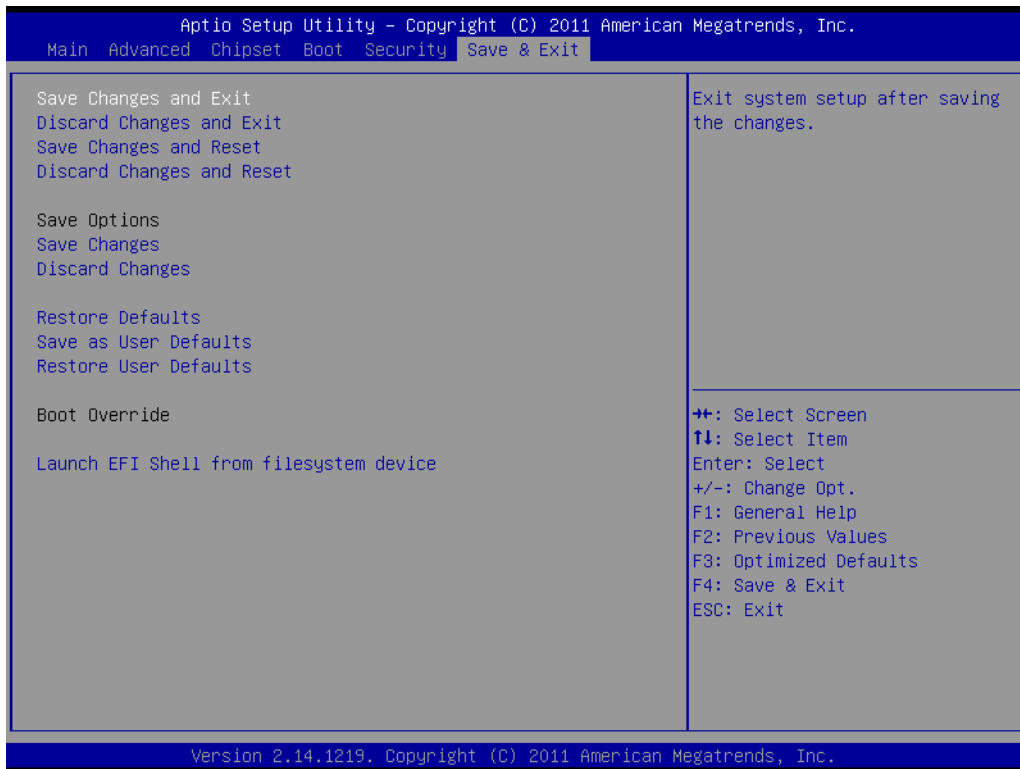

Figure 3.32 Save & Exit

- **Save changes and exit***
When you have completed system configuration, select this option to save your changes, exit BIOS setup and boot into the OS so the new system configuration parameters can take effect.
- **Discard changes and exit**
Select this option to quit Setup without making any permanent changes to the system configuration.
- **Save changes and Reset**
When you have completed system configuration, select this option to save your changes, exit BIOS setup and reboot into the computer so the new system configuration parameters can take effect.
- **Discard changes and Reset**
Select this option to quit Setup and reset computer without making any permanent changes to the system configuration.
- **Save Changes**
Select this option to save your changes.
- **Discard Changes**
Select this option to discard your changes.
- **Restore Defaults**
Select this option to restore BIOS configuration as origin.
- **Save as User Defaults**
Select this option to save user's configuration.
- **Restore User Defaults**
Select this option to restore BIOS to user's configuration.
- **Launch EFI Shell from file system device**
This option allows you to attempt to launch the EFI Shell application (shellx64.efi) from one of the available file system devices.

*When you make some critical changes, the system will still reboot even if you choose "Save changes and exit".

Chapter 4

Value-Added Software Services

4.1 Value-Added Software Services

Software API are interface that define the ways in which an application program may request services from libraries and/or operating systems. They provide not only the underlying drivers required but also a rich set of user-friendly, intelligent and integrated interfaces, which speed development, enhance security and offer add-on value. API make Advantech embedded platforms easier and simpler to adopt and operate with customer applications. These API and utilities are for XP only, so if users need a Linux version API and utility, then contact an Advantech representative for support.

4.1.1 Software API

4.1.1.1 Control

GPIO



General Purpose Input/Output is a flexible parallel interface that allows a variety of custom connections. allows users to monitor the level of signal input or set the output status to switch on/off the device. Our API also provides Programmable GPIO, which allows developers to dynamically set the GPIO input or output status.

SMBus



SMBus is the System Management Bus defined by Intel® Corporation in 1995. It is used in personal computers and servers for low-speed system management communications. Today, SMBus is used in all types of embedded systems. The SMBus API allows a developer to interface a Windows XP or CE PC to a downstream embedded system environment and transfer serial messages using the SMBus protocols, allowing multiple simultaneous device control.

4.1.1.2 Monitor

Watchdog



A watchdog timer (WDT) is a device that performs a specific operation after a certain period of time if something goes wrong and the system does not recover on its own. A watchdog timer can be programmed to perform a warm boot (restarting the system) after a certain number of seconds.

Hardware Monitor



The Hardware Monitor (HWM) API is a system health supervision API that inspects certain condition indexes, such as fan speed, temperature and voltage.

Chapter 5

Chipset Software
Installation Utility

5.1 Before You Begin

To facilitate the installation of the enhanced display drivers and utility software, read the instructions in this chapter carefully. The drivers for PCE-3026 are located on the software installation CD. The driver in the folder of the driver CD will guide and link you to the utilities and drivers for Windows. Updates are provided via Service Packs from Microsoft®.

Note! *The files on the software installation CD are compressed. Do not attempt to install the drivers by copying the files manually. You must use the supplied SETUP program to install the drivers.*



Before you begin, it is important to note that most display drivers need to have the relevant software application already installed in the system prior to installing the enhanced display drivers. In addition, many of the installation procedures assume that you are familiar with both the relevant software applications and operating system commands. Review the relevant operating system commands and the pertinent sections of your application software's user manual before performing the installation.

5.2 Introduction

The Intel® Chipset Device Software installs Windows* INF files to the target system. These files outline to the operating system how to configure the Intel® chipset components in order to ensure that the following features function properly:

- PCIe Support
- SATA Storage Support
- USB Support
- Identification of Intel® Chipset Components in
- The Device Manager

5.3 Windows® XP / Windows® 7 Driver Setup

1. Insert the driver CD into your system's CD-ROM drive. You can see the driver folder items. Navigate to the "01-Chipset/Windows 7 &XP" folder and click "setup.exe" to complete the installation of the driver.

Note! *Wrong driver installation may cause unexpected system instability.*



The drivers on this CD support both Windows XP 32-bit /64-bit and Windows 7 32-bit/64-bit.



Chapter 6

Integrated Graphic
Device Setup

6.1 Introduction

The Intel® LGA1155 CPUs have integrated graphics controllers. You need to install the VGA driver to enable this function, which includes the following features:

- **Optimized integrated graphic solution:** Intel Graphics Flexible Display Interface supports versatile display options and 32-bit 3D graphics engine. Dual independent display, enhanced display modes for widescreen flat panels for extend, twin, and clone dual display mode, and optimized 3D support deliver an intensive and realistic visual experience.

6.2 Windows XP/Windows 7 Driver Setup

Note! Before installing this driver, make sure the INF driver has been installed in your system. See Chapter 5 for information on installing the INF driver.



Insert the driver CD into your system's CD-ROM drive. You can see the driver folder items. Navigate to the "02_VGA/your OS/OS type/" folder and click "setup.exe" to complete the installation of the driver. If "00.Dot Net Framework" is required, please check "05-others" folder.

Note! Wrong driver installation may cause unexpected system instability.

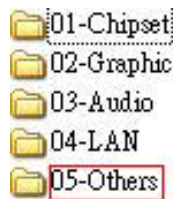
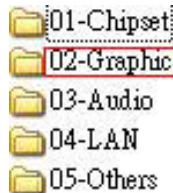

Chapter 7

LAN Configuration

7.1 Introduction

PCE-3026 has dual Gigabit Ethernet LANs via dedicated PCI Express x1 lanes (Intel 82579V (LAN1) and 82583V (LAN2) that offer bandwidth of up to 500 MB/sec, eliminating the bottleneck of network data flow and incorporating Gigabit Ethernet at 1000 Mbps.

7.2 Installation

Note! Before installing the LAN drivers, make sure the CSI utility has been installed on your system. See Chapter 5 for information on installing the CSI utility.



7.3 Win XP /Win 7 Driver Setup (LAN)

Insert the driver CD into your system's CD-ROM drive. Navigate to the "04-LAN" folder and click "Autorun.exe" to complete the installation of the driver.

Note! Wrong driver installation may cause unexpected system instability.

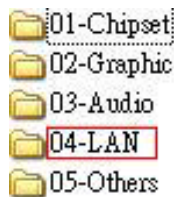

Chapter 8

Intel ME

8.1 Introduction

The Intel® ME software components that need to be installed depend on the system's specific hardware and firmware features. The installer detects the system's capabilities and installs the relevant drivers and applications.

8.2 Installation

Insert the driver CD into your system's CD-ROM drive. Navigate to the "05-Others/ME" folder and click "setup.exe" to complete the installation of the driver.

Note! *Wrong driver installation may cause unexpected system instability.*



Appendix **A**

Programming the
Watchdog Timer

A.1 Introduction

The PCE-3026's watchdog timer can be used to monitor system software operation and take corrective action if the software fails to function within the programmed period. This section describes the operation of the watchdog timer and how to program it.

A.1.1 Watchdog timer overview

The watchdog timer is built in to the NCT6776D super I/O controller. It provides the following user programmable functions:

- Can be enabled and disabled via user's program
- Timer can be set from 1 to 255 seconds or 1 to 255 minutes
- Generates a reset signal if the software fails to reset the timer before time-out

A.1.2 Programming the watchdog timer

The I/O port address of the watchdog timer is 2E (hex) and 2F (hex). 2E (hex) is the address port. 2F (hex) is the data port. You must first write an address value into address port 2E (hex), then write/read data to/from the assigned register through data port 2F (hex).

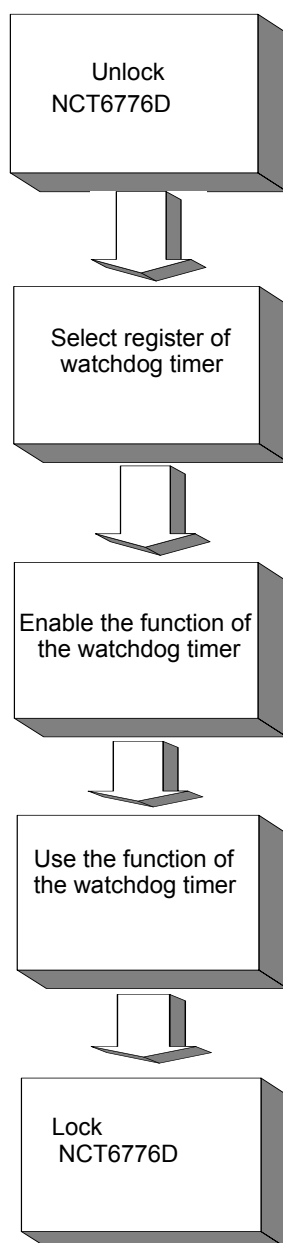
Table A.1: Watchdog timer registers

Address of register (2E)	Attribute Read/Write	Value (2F) & description
87 (hex)	-----	Write this address to I/O address port 2E (hex) twice to unlock the NCT6776D.
07 (hex)	write	Write 08 (hex) to select register of watchdog timer.
30 (hex)	write	Write 01 (hex) to enable the function of the watchdog timer. Disabled is set as default.
F5 (hex)	write	Set seconds or minutes as units for the timer. Write 0 to bit 3: set second as counting unit. [default]. Write 1 to bit 3: set minutes as counting unit. Write 1 to bit 4: Watchdog timer count mode is 1000 times faster. If bit 3 is 0, the count mode is 1/1000 seconds mode. If bit 3 is 1, the count mode is 1/1000 minutes mode.

F6 (hex)	write	0: stop timer [default] 01~FF (hex): The amount of the count, in seconds or minutes, depends on the value set in register F5 (hex). This number decides how long the watchdog timer waits for strobe before generating an interrupt or reset signal. Writing a new value to this register can reset the timer to count with the new value.
F7 (hex)	read/write	Bit 6: Write 1 to enable keyboard to reset the timer, 0 to disable.[default] Bit 5: Write 1 to generate a timeout signal immediately and automatically return to 0. [default=0] Bit 4: Read status of watchdog timer, 1 means timer is "timeout".
AA (hex)	-----	Write this address to I/O port 2E (hex) to lock the NCT6776D.

A.1.3 Example program

1. Enable watchdog timer and set 10 sec. as timeout interval

```

;-----
Mov dx,2eh          ; Unlock NCT6776D
Mov al,87h
Out dx,al
Out dx,al
;-----
Mov al,07h         ; Select registers of watchdog timer
Out dx,al
Inc dx
Mov al,08h
Out dx,al
;-----
Dec dx            ; Enable the function of watchdog timer
Mov al,30h
Out dx,al
Inc dx
In al,dx
Or al,01h
Out dx,al
;-----
Dec dx           ; Set second as counting unit
Mov al,0f5h
Out dx,al
Inc dx
In al,dx
And al,not 08h
Out dx,al
;-----
Dec dx           ; Set timeout interval as 10 seconds and start counting
Mov al,0f6h

```

```

Out    dx,al
Inc    dx
Mov    al,10      ; 10 seconds
Out    dx,al

```

```

;-----
Dec dx          ; Lock NCT6776D
Mov    al,0aah
Out    dx,al

```

2. Enable watchdog timer and set 5 minutes as timeout interval

```

;-----
Mov dx,2eh      ; Unlock NCT6776D
Mov al,87h
Out dx,al
Out dx,al

```

```

;-----
Mov al,07h      ; Select registers of watchdog timer
Out    dx,al
Inc    dx
In     al,dx
Or     al,08h
Out    dx,al

```

```

;-----
Dec dx          ; Enable the function of watchdog timer
Mov    al,30h
Out    dx,al
Inc    dx
Mov    al,01h
Out    dx,al

```

```

;-----
Dec dx          ; Set minute as counting unit
Mov    al,0f5h
Out    dx,al
Inc    dx
In     al,dx
Or     al,08h
Out    dx,al

```

```

;-----
Dec dx          ; Set timeout interval as 5 minutes and start counting
Mov    al,0f6h
Out    dx,al
Inc    dx
Mov    al,5      ; 5 minutes
Out    dx,al

```

```

;-----

```

```
Dec dx          ; Lock NCT6776D
Mov  al,0aah
Out  dx,al
```

3. Enable watchdog timer to be reset by mouse

```
-----
Mov dx,2eh      ; Unlock NCT6776D
Mov al,87h
Out dx,al
Out dx,al
-----
Mov al,07h      ; Select registers of watchdog timer
Out  dx,al
Inc  dx
Mov  al,08h
Out  dx,al
-----
Dec dx          ; Enable the function of watchdog timer
Mov  al,30h
Out  dx,al
Inc  dx
In   al,dx
Or   al,01h
Out  dx,al
-----
Dec dx          ; Enable watchdog timer to be reset by mouse
Mov  al,0f7h
Out  dx,al
Inc  dx
In   al,dx
Or  al,80h
Out  dx,al
-----
Dec dx          ; Lock NCT6776D
Mov  al,0aah
Out  dx,al
```

4. Enable watchdog timer to be reset by keyboard

```
-----
Mov dx,2eh      ; Unlock NCT6776D
Mov al,87h
Out dx,al
Out dx,al
-----
Mov al,07h      ; Select registers of watchdog timer
```

```

Out    dx,al
Inc    dx
Mov    al,08h
Out    dx,al
;-----
Dec dx          ; Enable the function of watchdog timer
Mov    al,30h
Out    dx,al
Inc    dx
Mov    al,01h
Out    dx,al
;-----
Dec dx          ; Enables watchdog timer to be strobe reset by keyboard
Mov    al,0f7h
Out    dx,al
Inc    dx
In     al,dx
Or    al,40h
Out    dx,al
;-----
Dec dx          ; Lock NCT6776D
Mov    al,0aah
Out    dx,al

5.   Generate a time-out signal without timer counting
;-----
Mov dx,2eh      ; Unlock NCT6776D
Mov al,87h
Out dx,al
Out dx,al
;-----
Mov al,07h      ; Select registers of watchdog timer
Out    dx,al
Inc    dx
Mov    al,08h
Out    dx,al
;-----
Dec dx          ; Enable the function of watchdog timer
Mov    al,30h
Out    dx,al
Inc    dx
Mov    al,01h
Out    dx,al
;-----
Dec dx          ; Generate a time-out signal

```

```
Mov    al,0f7h
Out    dx,al    ;Write 1 to bit 5 of F7 register
Inc    dx
In     al,dx
Or    al,20h
Out    dx,al
;-----
Dec dx    ; Lock NCT6776D
Mov    al,0aah
Out    dx,al
```

Appendix **B**

I/O Pin Assignments

B.1 Parallel Port Connector (LPT1)

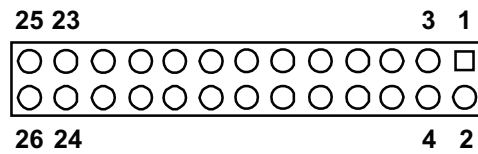

Table B.1: Parallel port connector (LPT1)

Pin	Signal	Pin	Signal
1	STROBE*	2	AUTOFD*
3	D0	4	ERR
5	D1	6	INIT*
7	D2	8	SLCTINI*
9	D3	10	GND
11	D4	12	GND
13	D5	14	GND
15	D6	16	GND
17	D7	18	GND
19	ACK*	20	GND
21	BUSY	22	GND
23	PE	24	GND
25	SLCT	26	N/C

* low active

B.2 VGA Connector (VGA1)

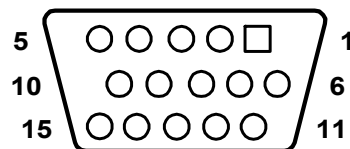

Table B.2: VGA connector (VGA1)

Pin	Signal	Pin	Signal
1	RED	9	VCC
2	GREEN	10	GND
3	BLUE	11	N/C
4	N/C	12	SDT
5	GND	13	H-SYNC
6	GND	14	V-SYNC
7	GND	15	SCK
8	GND		

B.3 RS 232 Serial Port (COM12)

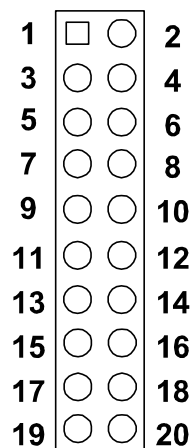

Table B.3: RS-232 serial port (COM12)

Pin	Signal
1	COM1_DCD
2	COM1_DSR
3	COM1_SIN
4	COM1_RTS
5	COM1_SOUT
6	COM1_CTS
7	COM1_DTR
8	COM1_RI
9	GND
10	GND
11	COM2_DCD
12	COM2_DSR
13	COM2_SIN
14	COM2_RTS
15	COM2_SOUT
16	COM2_CTS
17	COM2_DTR
18	COM2_RI
19	GND
20	GND

B.4 USB 2.0 Header (USB12~56)

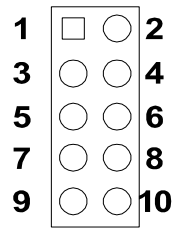

Table B.4: USB Header (USB12~56, take USB 12 as example)

Pin	Signal	Pin	Signal
1	USB1_VCC5	6	USB2_D+
2	USB2_VCC5	7	GND
3	USB1_D-	8	GND
4	USB2_D-	9	Key
5	USB1_D+	10	NC

B.5 PS/2 Keyboard/Mouse Connector (KBMS1)

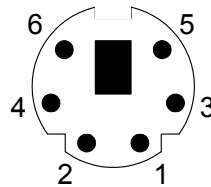

Table B.5: PS/2 keyboard/mouse connector (KBMS1)

Pin	Signal
1	KB DATA
2	MS DATA
3	GND
4	VCC
5	KB CLOCK
6	MS CLOCK

B.6 CPU Fan Power Connector (CPUFAN1)

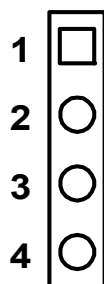

Table B.6: CPU fan power connector (CPUFAN1)

Pin	Signal
1	GND
2	+12V
3	Detect
4	NC

B.7 Reset Connector (FP1 / RESET)

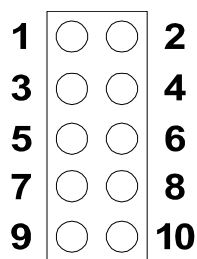

Table B.7: Reset connector (FP1 / RESET)

Pin	Signal
1	HDD_LED+
2	HDD_LED-
3	PW_LED
4	GND
5	N/C
6	N/C
7	RESET#
8	GND
9	PWR-BTN
10	GND

B.8 Hi-definition Audio Link Connector (HDAUD1)

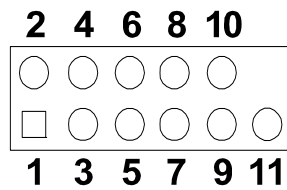

Table B.8: Hi-definition audio link connector (HDAUD1)

Pin	Signal	Pin	Signal
1	ACZ_VCC	2	GND
3	ACZ_SYNC	4	ACZ_BITCLK
5	ACZ_SDOUT	6	ACZ_SDIN0
7	ACZ_SDIN1	8	-ACZ_RST
9	ACZ_12V	10	GND
11	GND	12	N/C

B.9 LAN1 and LAN2 LED Connector (LANLED1)

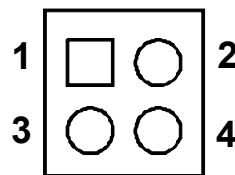

Table B.9: LAN1 and LAN2 LED connector (LANLED1)

Pin	Signal
1	#LAN1_ACT
2	#LAN2_ACT
3	V33_AUX
4	V33_AUX

B.10 GPIO Header (GPIO1)

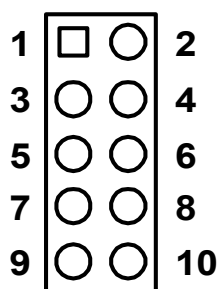

Table B.10: GPIO header (GPIO1)

Pin	Signal
1	SIO_GPIO0
2	SIO_GPIO4
3	SIO_GPIO1
4	SIO_GPIO5
5	SIO_GPIO2
6	SIO_GPIO6
7	SIO_GPIO3
8	SIO_GPIO7
9	VCC_GPIO
10	GND

B.11 JIR1



Table B.11: JIR1

Pin	Signal
1	5V
3	NC
5	IRRX_SIO
7	GND
9	IRTX_SIO

B.12 JCASE1

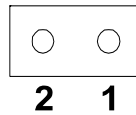

Table B.12: JCASE1

Pin	Signal
1	CASEOP#
2	GND

B.13 LPC1

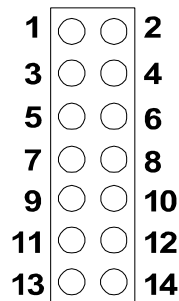

Table B.13: LPC1

Pin	Signal
1	CLK33M_LPC0
2	LPC_AD1
3	PLTRST_LPC0#
4	LPC_AD0
5	LPC_FRAME#
6	3.3V
7	LPC_AD3
8	GND
9	LPC_AD2
10	LPC1_SMB_CLK
11	PCI_SERIRQ
12	LPC1_SMB_DATA
13	5VSB
14	5VSB

B.14 PWR1

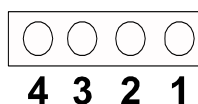

Table B.14: PWR1

Pin	Signal
1	5V
2	GND
3	GND
4	12V

B.15 DVI1

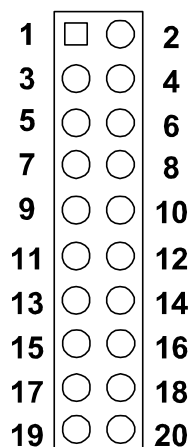

Table B.15: DVI1

Pin	Signal
1	TMDS0_Z_D0-
2	5V
3	TMDS0_Z_D0+
4	TMDS0_Z_CLK-
5	GND
6	TMDS0_Z_CLK+
7	TMDS0_Z_D1-
8	GND
9	TMDS0_Z_D1+
10	TMDS0_DDC_SC
11	GND
12	TMDS0_DDC_SD
13	TMDS0_Z_D2-
14	TMDS0_HPD
15	TMDS0_Z_D2+
16	NC

Table B.15: DVI1

17	5V
18	NC
19	NC
20	NC

B.16 Fixed I/O Ranges Decoded by Intel PCH

Table B.16: Fixed I/O Ranges Decoded by Intel PCH

I/O Address	Read Target	Write Target	Internal Unit
00h-08h	DMA Controller	DMA Controller	DMA
09h-0Eh	RESERVED	DMA Controller	DMA
0Fh	DMA Controller	DMA Controller	DMA
10h-18h	DMA Controller	DMA Controller	DMA
19h-1Eh	RESERVED	DMA Controller	DMA
1Fh	DMA Controller	DMA Controller	DMA
20h-21h	Interrupt Controller	Interrupt Controller	Interrupt
24h-25h	Interrupt Controller	Interrupt Controller	Interrupt
28h-29h	Interrupt Controller	Interrupt Controller	Interrupt
2Ch-2Dh	Interrupt Controller	Interrupt Controller	Interrupt
2E-2F	LPC SIO	LPC SIO	Forwarded to LPC
30h-31h	Interrupt Controller	Interrupt Controller	Interrupt
34h-35h	Interrupt Controller	Interrupt Controller	Interrupt
38h-39h	Interrupt Controller	Interrupt Controller	Interrupt
3Ch-3Dh	Interrupt Controller	Interrupt Controller	Interrupt
40h-42h	Timer/Counter	Timer/Counter	PIT (8254)
43h	RESERVED	Timer/Counter	PIT
4E-4F	LPC SIO	LPC SIO	Forwarded to LPC
50h-52h	Timer/Counter	Timer/Counter	PIT
53h	RESERVED	Timer/Counter	PIT
60h	Microcontroller	Microcontroller	Forwarded to LPC
61h	NMI Controller	NMI Controller	Processor I/F
62h	Microcontroller	Microcontroller	Forwarded to LPC
64h	Microcontroller	Microcontroller	Forwarded to LPC
66h	Microcontroller	Microcontroller	Forwarded to LPC
70h	RESERVED	NMI and RTC Controller	RTC
71h	RTC Controller	RTC Controller	RTC
72h	RTC Controller	NMI and RTC Controller	RTC
73h	RTC Controller	RTC Controller	RTC
74h	RTC Controller	NMI and RTC Controller	RTC
75h	RTC Controller	RTC Controller	RTC
76h	RTC Controller	NMI and RTC Controller	RTC
77h	RTC Controller	RTC Controller	RTC
80h	DMA Controller, or LPC, or PCI	DMA Controller and LPC or PCI	DMA
81h-83h	DMA Controller	DMA Controller	DMA

Table B.16: Fixed I/O Ranges Decoded by Intel PCH

84h-86h	DMA Controller	DMA Controller and LPC or PCI	DMA
87h	DMA Controller	DMA Controller	DMA
88h	DMA Controller	DMA Controller and LPC or PCI	DMA
89h-8Bh	DMA Controller	DMA Controller	DMA
8Ch-8Eh	DMA Controller	DMA Controller and LPC or PCI	DMA
08Fh	DMA Controller	DMA Controller	DMA
90h-91h	DMA Controller	DMA Controller	DMA
92h	Reset Generator	Reset Generator	Processor I/F
93h-9Fh	DMA Controller	DMA Controller	DMA
A0h-A1h	Interrupt Controller	Interrupt Controller	Interrupt
A4h-A5h	Interrupt Controller	Interrupt Controller	Interrupt
A8h-A9h	Interrupt Controller	Interrupt Controller	Interrupt
ACh-ADh	Interrupt Controller	Interrupt Controller	Interrupt
B0h-B1h	Interrupt Controller	Interrupt Controller	Interrupt
B2h-B3h	Power Management	Power Management	Power Management
B4h-B5h	Interrupt Controller	Interrupt Controller	Interrupt
B8h-B9h	Interrupt Controller	Interrupt Controller	Interrupt
BCh-BDh	Interrupt Controller	Interrupt Controller	Interrupt
C0h-D1h	DMA Controller	DMA Controller	DMA
D2h-DDh	RESERVED	DMA Controller	DMA
DEh-DFh	DMA Controller	DMA Controller	DMA
F0h	PCI and Master Abort1	FERR#/IGNNE# / Interrupt Controller	Processor I/F
170h-177h	SATA Controller or PCI	SATA Controller or PCI	Forwarded to SATA
1F0h-1F7h	SATA Controller or PCI	SATA Controller or PCI	Forwarded to SATA
376h	SATA Controller or PCI	SATA Controller or PCI	Forwarded to SATA
3F6h	SATA Controller or PCI	SATA Controller or PCI	Forwarded to SATA
4D0h-4D1h	Interrupt Controller	Interrupt Controller	Interrupt
CF9h	Reset Generator	Reset Generator	Processor I/F

B.17 System I/O Ports

Table B.17: System I/O Ports

I/O Address (Hex)	Device
290h-29Fh	H/W Monitor
2F8h-2FFh	Communication Port (2)
378h-37Fh	ECP Printer Port (LPT1)
3B0h-3BBh	Graphics
3C0h-3DFh	Graphics
3F8h-3FFh	Communication Port (2)
400h-47Fh	PMBASE
500h-57Fh	GPIOBASE
600h-67Fh	PCA-COM485 Module I/O used
778h-77Fh	ECP Printer Port (LPT1)
C80h-C9Fh	Communication port (3-6) for PCA-COM232 module
CA0h-CBFh	Communication port (8-11) for PCA-COM485 module

B.18 Interrupt Assignments

Table B.18: Interrupt Assignments

Interrupt#	Interrupt source
NMI	Parity error detected
IRQ0	System timer
IRQ1	Keyboard
IRQ2	Interrupt from controller 2
IRQ3	Communication port (COM2)
IRQ4	Communication port (COM1)
IRQ5	Available
IRQ6	Available
IRQ7	LPT1
IRQ8	System COMS/Real-time clock
IRQ9	SCI IRQ
IRQ10	Communication port (3-6) for PCA-COM232 module
IRQ11	Communication port (8-11) for PCA-COM485 module
IRQ12	PS/2 mouse
IRQ13	Numeric data processor
IRQ14	Available
IRQ15	Available

B.19 1 MB Memory Map

Table B.19: 1 MB memory map

Address Range	Device
E8000h - FFFFFh	BIOS
D0000h - E7FFFh	Unused
C0000h - CFFFFh	VGA BIOS
A0000h - BFFFFh	Video Memory
00000h - 9FFFFh	Base memory

Appendix **C**

Programming the
GPIO

C.1 Supported GPIO Register

Below are the detailed descriptions of the GPIO addresses and a programming sample.

C.2 GPIO Registers

Bank	Offset	Description
09h	30h	Write 1 to bit 7 to enable GPIO
07h	E0h	GPIO I/O Register When set to a '1', respective GPIO port is programmed as an input port. When set to a '0', respective GPIO port is programmed as an output port.
07h	E1h	GPIO Data Register If a port is programmed to be an output port, then its respective bit can be read/written. If a port is programmed to be an input port, then its respective bit can only be read.
07h	E2h	GPIO Inversion Register When set to a '1', the incoming/outgoing port value is inverted. When set to a '0', the incoming/outgoing port value is the same as in data register.

C.3 GPIO Example Program-1

Enter the extended function mode, interruptible double-write

```
MOV DX,2EH  
MOV AL,87H  
OUT DX,AL  
OUT DX,AL
```

Configure logical device, configuration register CRE0,CRE1,CRE2

```
MOV DX,2EH  
MOV AL,09H  
OUT DX,AC  
DEC DX  
MOV AL,30H  
OUT DX,AL  
INC DX  
IN AL,DX  
OR AL,10000000B  
DEC DX  
MOV AL,07H  
OUT DX,AL
```

```
INC DX
MOV AL,07H ; Select logical device 7
OUT DX,AL ;
DEC DX
MOV AL,E0H
OUT DX,AL
INC DX
MOV AL,00H ; 1:Input 0:output for GPIO respective
OUT DX,AL
DEC DX
MOV AL,E2H ;
OUT DX,AL
INC DX
MOV AL,00H ;Set GPIO is normal not inverter
OUT DX,AL;
DEC DX
MOV AL,E1H
OUT DX,AL
INC DX
MOV AL,??H ; Put the output value into AL
OUT DX,AL

-----
Exit extended function mode |
-----

MOV DX,2EH
MOV AL,AAH
OUT DX,AL
```

ADVANTECH

Enabling an Intelligent Planet

www.advantech.com

Please verify specifications before quoting. This guide is intended for reference purposes only.

All product specifications are subject to change without notice.

No part of this publication may be reproduced in any form or by any means, electronic, photocopying, recording or otherwise, without prior written permission of the publisher.

All brand and product names are trademarks or registered trademarks of their respective companies.

© Advantech Co., Ltd. 2012