

Type 12 Mild Steel Miniature Pushbutton Enclosures

MPB Series



Application

- Designed to accept 22mm miniature oil tight pushbuttons, switches and pilot lights.
- Provides protection from dirt, dust, oil and water.

Standards

- UL 508 Type 12 and 13
- CSA Type 12 and 13
- **Complies with**
 - NEMA Type 12 and 13
 - JIC EMP-1-1967
 - JIC EGP-1-1967
 - IEC 60529, IP54
- Appropriate components are required to maintain these standards.

Construction

- Formed 14 gauge steel except the MPB1 which is 16 gauge.
- Smooth continuously welded seams.
- Welded brackets provide for enclosure mounting.
- Captive cover screws thread into sealed wells.
- Larger enclosures provide internally hinged removable covers, designed to hold the cover open during wiring (see table).
- Oil resistant gasket and adhesive.
- A bonding stud is provided on the door and a grounding stud is provided on the enclosure.

Finish

- Cover and enclosure are phosphatized and finished in ANSI 61 gray powder coating.

Accessories

- Hole Plugs
- Ground Wire Kits
- Pedestal and Base

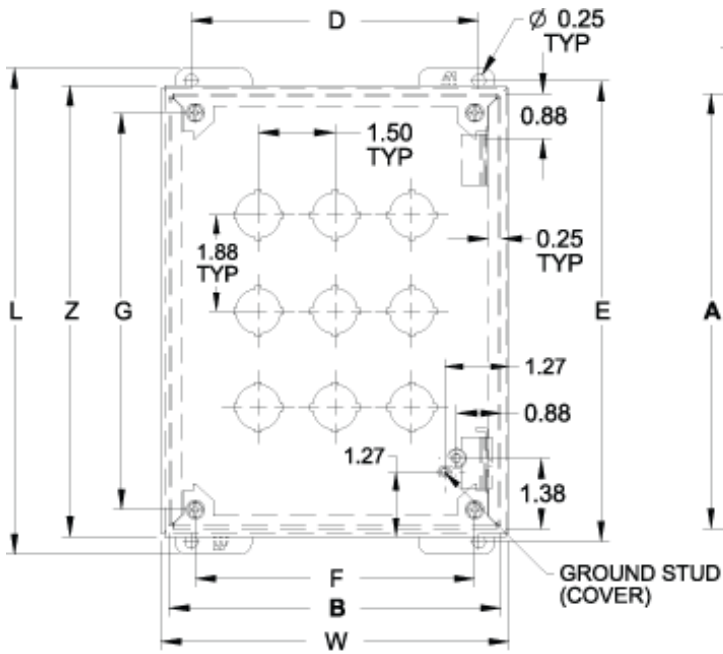

Front View
Body Type MPB6 through MPB12
(Hinged)

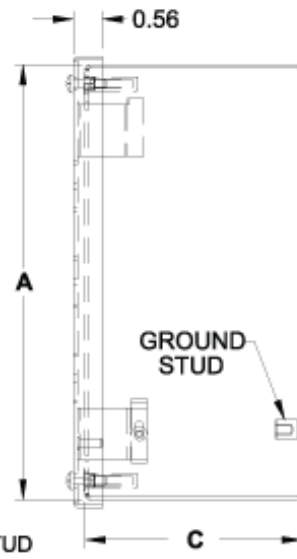

Side View

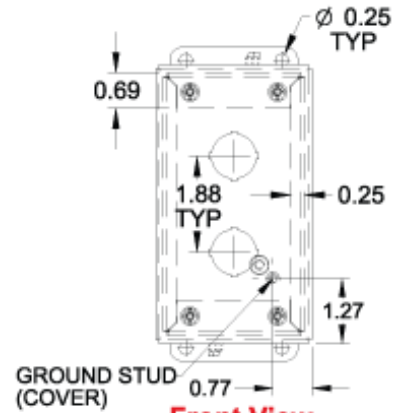

Front View
Body Type MPB1 through MPB4
(Not Hinged)

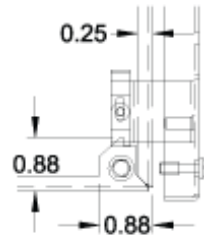

Hinge Detail
Retractable pin allows door to be
mounted on left or right side

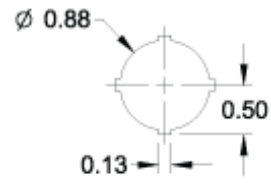

22.5mm Detail

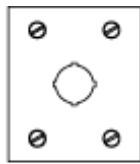

MPB1

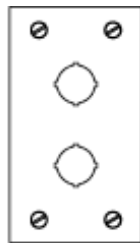

MPB2

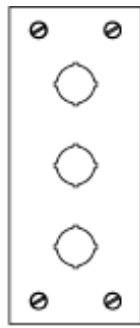

MPB3

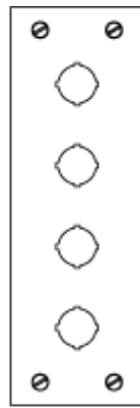

MPB4

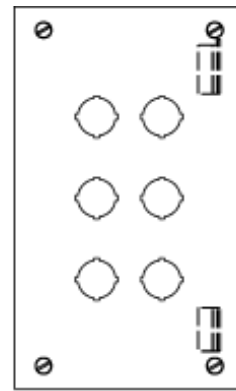

MPB6

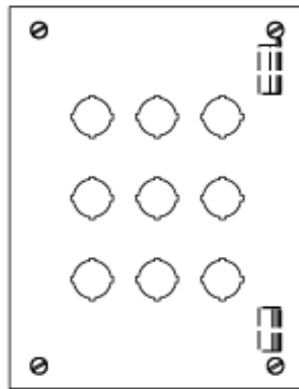

MPB9

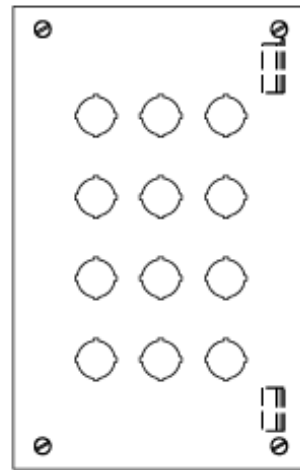

MPB12

Part No.	No. of Holes	A	B	C	D	E	F	G	Overall Dimensions			Ship Wt. (lbs)
									L	W	Z	
MPB1 ¹	1	3.25	2.75	3.50	1.88	3.75	1.71	2.50	4.25	3.06	3.56	2
MPB2 ¹	2	5.13	2.75	3.50	1.88	5.63	1.71	4.38	6.13	3.06	5.44	3
MPB3 ¹	3	7.00	2.75	3.50	1.88	7.50	1.71	6.25	8.00	3.06	7.31	3
MPB4 ¹	4	8.88	2.75	3.50	1.88	9.38	1.71	8.13	9.88	3.06	9.19	4
MPB6	6	8.50	5.00	4.25	4.13	9.00	3.96	7.75	9.50	5.31	8.81	5
MPB9	9	8.50	6.50	4.25	5.63	9.00	5.46	7.75	9.50	6.81	8.81	6
MPB12	12	10.38	6.50	4.25	5.63	10.88	5.46	9.63	11.38	6.81	10.69	6

¹ Not hinged

Data subject to change without notice