

# LNE

## LNE LED Driver

54V 186.3W 1 Phase / LNE-54V185WACA

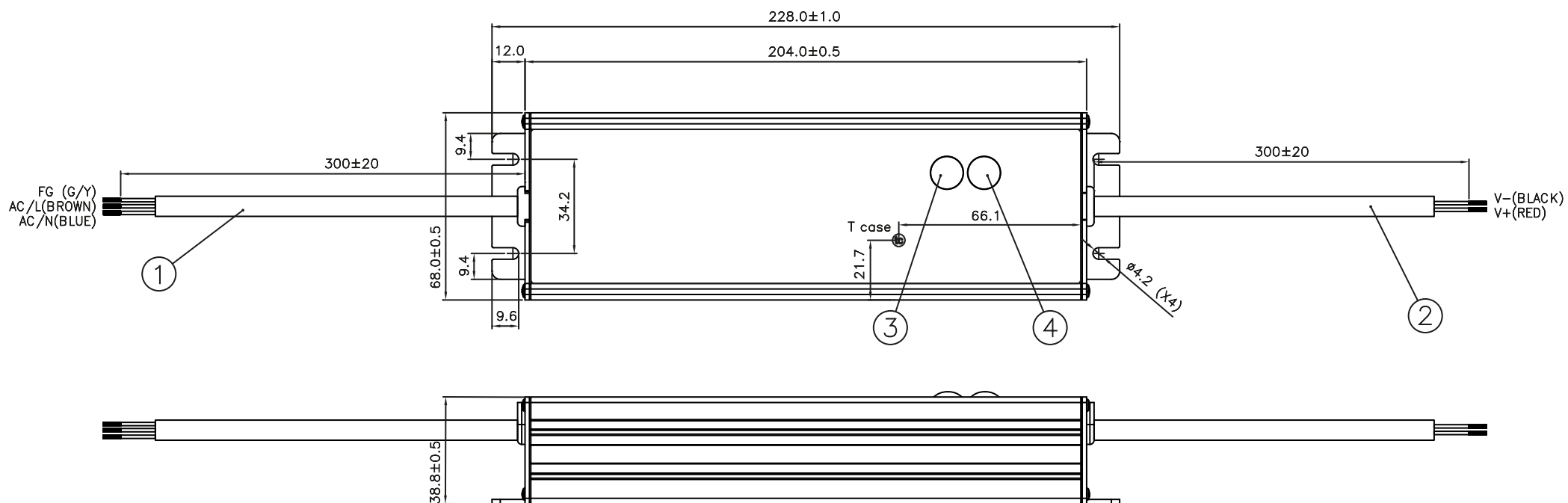

Item	Device Description
1	Input Cable
2	Output Cable
3	Vo Adjust (Constant Voltage Adjustment)
4	Io Adjust (Constant Current Adjustment)
tc	T case (tc): Temperature hot spot location on case.

# LNE

## LNE LED Driver

54V 186.3W 1 Phase / LNE-54V185WAAA

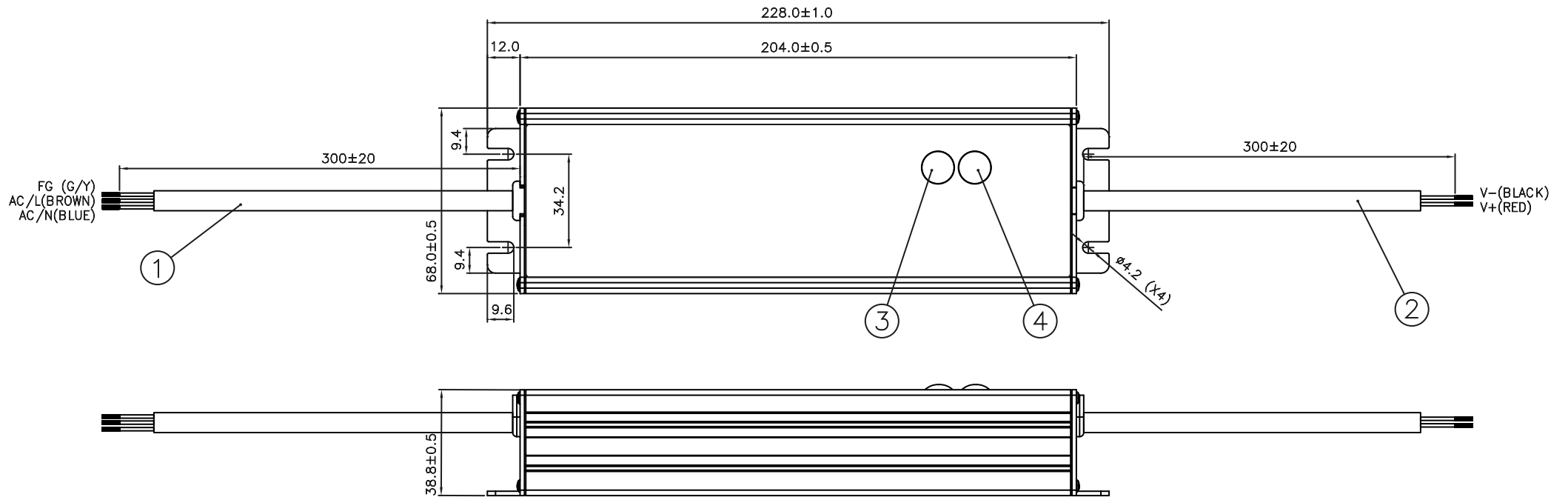

Item	Device Description
1	Input Cable
2	Output Cable
3	Vo Adjust (Constant Voltage Adjustment)
4	Io Adjust (Constant Current Adjustment)

# LNE

## LNE LED Driver

54V 186.3W 1 Phase / LNE-54V185WDCA

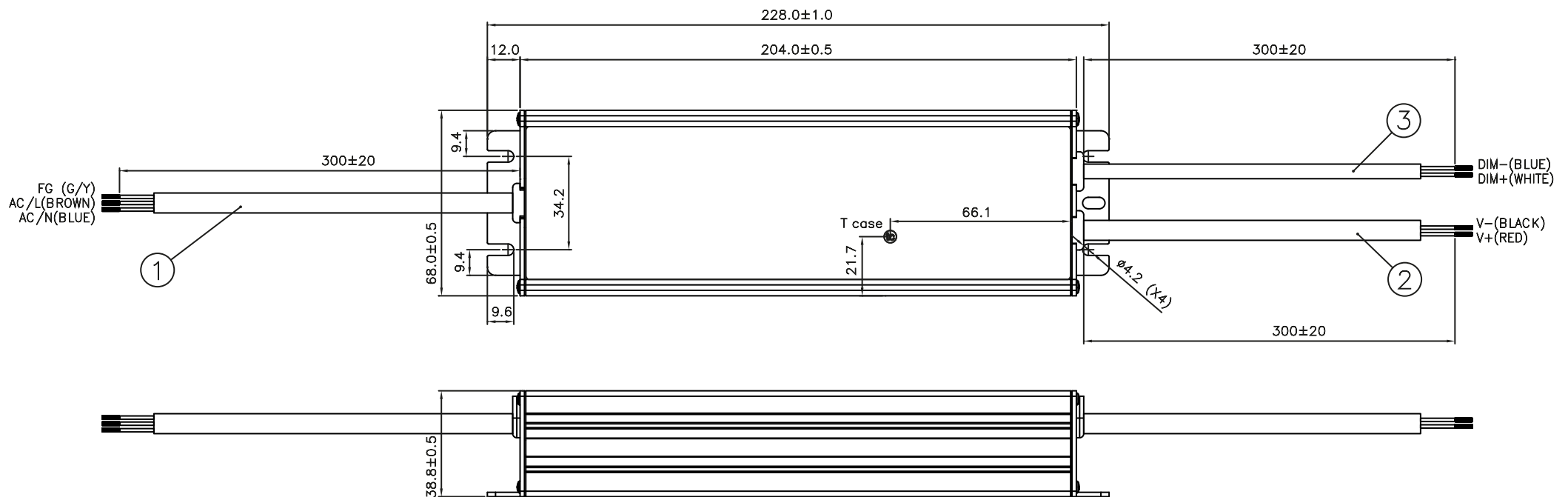

Item	Device Description
1	Input Cable
2	Output Cable
3	Dimming Cable
tc	T case (tc): Temperature hot spot location on case.

# LNE

## LNE LED Driver

54V 186.3W 1 Phase / LNE-54V185WDAA

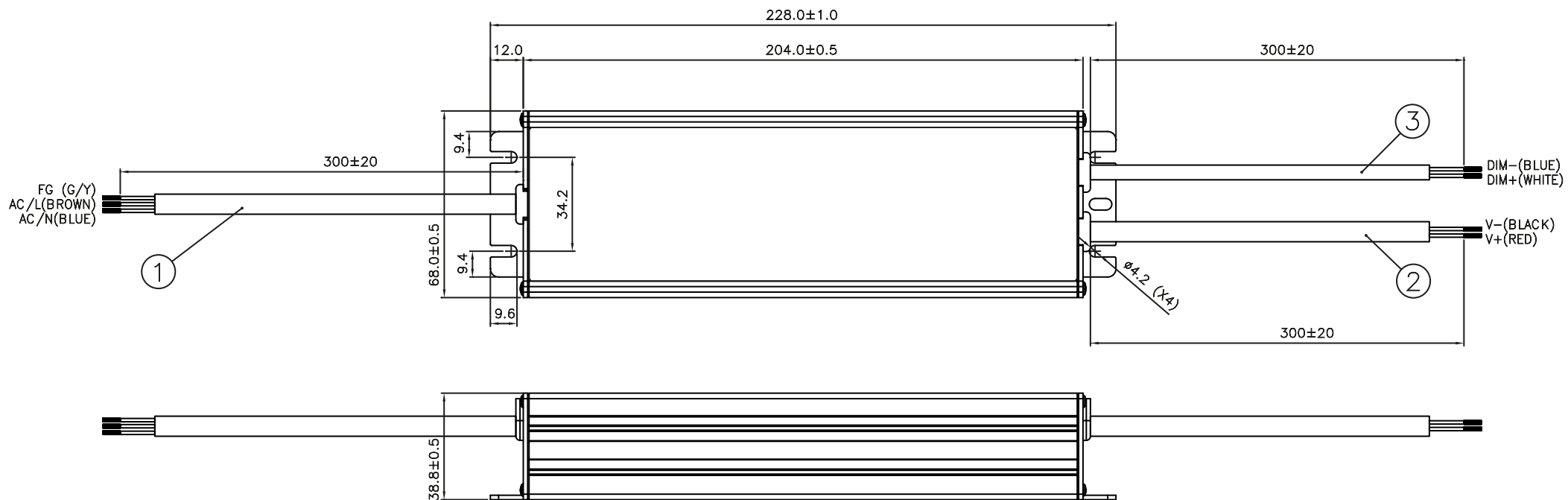

Item	Device Description
1	Input Cable
2	Output Cable
3	Dimming Cable