

# 8 Series Toggle Switches

## ■ Introduction

The **8 Series Toggles** is Copal Electronics' high-reliability miniature switch product offering. This product line meets and exceeds all basic international switch standards.

With **8** toggle options, PC and solder lug terminals, power and logic level current ratings, 1-4 pole and many circuit offerings these switches can be used in many industries and various applications within these industries.

Four of the **8 Series** lines are washable. Specifically designed for PC applications with automated solder and cleaning methods.

The **8 Series** is available with **UL** Recognition and **CSA** Certification upon request from the customer.

## ■ Applications





































- Communication equipment
- Computer peripheral equipment
- Measuring instruments
- Medical equipment
- Automotive diagnosis

The switches can be used in a wide range of fields from industrial to consumer equipment.

## ■ Features of 8 Series Toggles

- 1. Terminal style :**  
Solder, Straight, Right angle and vertical mount PC terminals.
- 2. Contacts :**  
Silver or gold.
- 3. Epoxy resin case :**  
UL94V-0 self-extinguishing epoxy.
- 4. Actuator styles :**  
Over 30 actuator variations.
- 5. Insulation between terminal and ground :**  
4 mm minimum.
- 6. Prevention of flux entry**  
The epoxy resin seal on bottom of the switch helps prevent the entry of solder and flux.
- 7. Insulation barrier :**  
Insulation barrier design between poles helps prevent short-circuiting between poles ensuring high reliability.
- 8. UL Recognized product      File No.E43275**
- 9. CSA Certified product      File No.LR38341**
- 10. For the UL Recognized and CSA Certified products please see page 412.**

# 8 Series Toggles Selection Table

Part No.	Name	Actuator shape	Number of poles	Switching function	Terminals	Page
<b>8A</b>	Standard toggle		1·2·3·4	ON — ON ON — OFF — ON (ON) — OFF — (ON) ON — OFF — (ON) ON — (ON) ※1/2 Poles ON — ON ON — OFF — ON ※3/4 Poles ON — ON — ON ON — ON — (ON) (ON) — ON — (ON) ※8A Type 2&4 Poles only	  Solder Lug Straight PC	389 } 391
<b>8B</b>	Mustang Toggle		1·2·3·4		  Solder Lug Straight PC	392 } 393
<b>8C</b>	Flatted Toggle		1·2·3·4		  Solder Lug Straight PC	394 } 395
<b>8D</b>	Long Toggle		1·2·3·4		  Solder Lug Straight PC	396 } 397
<b>8E</b>	Lever Lock Toggle		1·2·3·4		  Solder Lug Straight PC	398 } 399
<b>8F</b>	Splash Proof Toggle		1·2·3·4		  Solder Lug Straight PC	400 } 401
<b>8J</b>	Short Toggle		1·2·3·4		  Solder Lug Straight PC	402 } 403
<b>8S</b>	Color Tip Toggle		1·2·3·4		  Solder Lug Straight PC	404 } 405
<b>Washable</b>	<b>8G</b>	Short Toggle Washable	1·2	ON — ON ON — OFF — ON (ON) — OFF — (ON) ON — OFF — (ON) ON — (ON)	   Straight PC Right Angle Vertical	406 } 407
	<b>8GA</b>	Standard Toggle Washable	1·2		   Straight PC Right Angle Vertical	408
	<b>8GD</b>	Long Toggle Washable	1·2		   Straight PC Right Angle Vertical	409
	<b>8GS</b>	Color Tip Toggle Washable	1·2		   Straight PC Right Angle Vertical	410

( ) indicates momentary actuation

## ■ Terminals

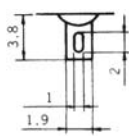
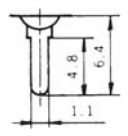
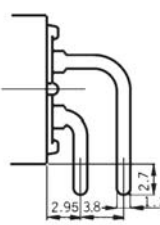
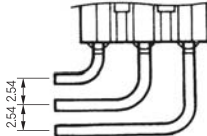
Solder Terminal (Style:1)	PC Straight (Style:2)	Right Angle (Style:4)	Vertical Mount (Style:6)
t=0.8 	t=0.8 PC 	t=0.8 R/A 	t=0.8 w=1.2 V/M 

## 8 Series Toggles

### Part Numbering

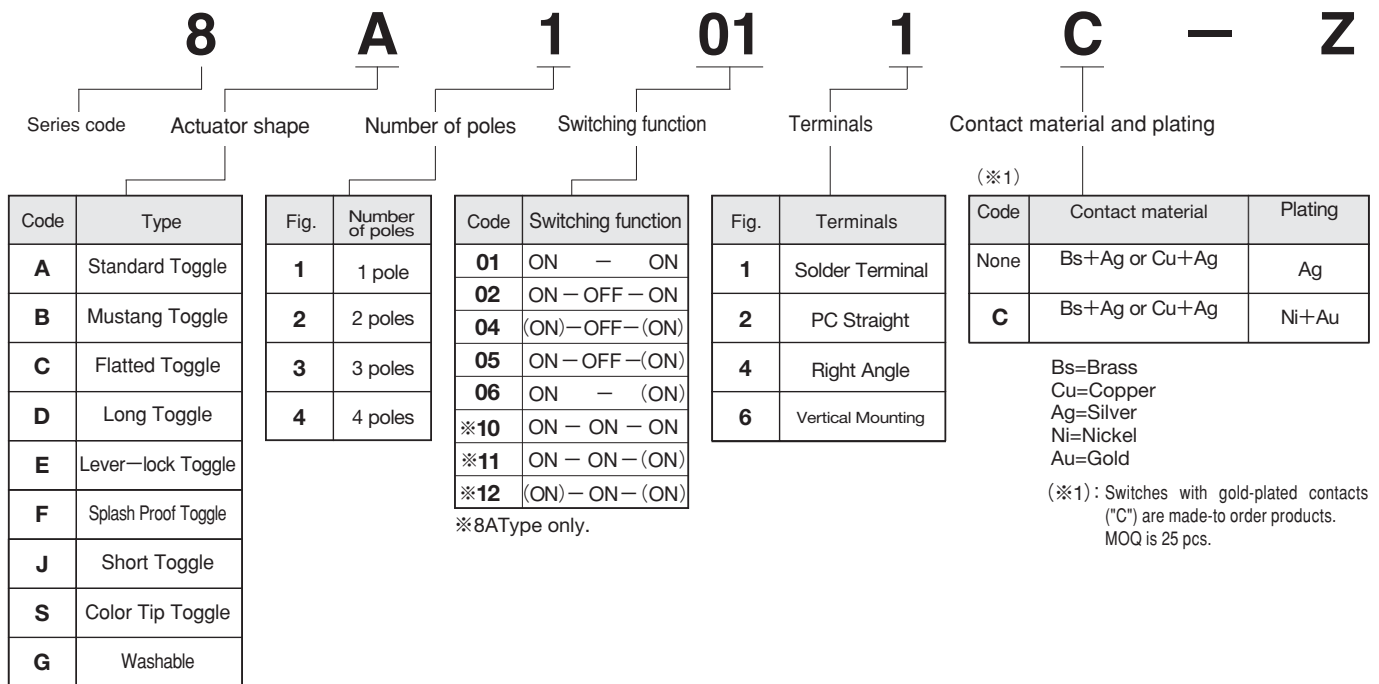

Note : Some combinations may not be available. Please check the "Table of Part Numbers" for each series.

### 8 Series Toggles Common Specifications

Contact specs.		Silver	Gold
Rating	Max.	AC125V 6A AC250V 3A DC30V 4A	AC125V 6A AC250V 3A DC20V 25mA
Initial contact resistance		10mΩ Max. (DC2~4V 1A)	20mΩ Max. (AC200μV 1.5mA)
Initial dielectric strength		AC1500V 1 minute	
Initial insulation resistance		1000MΩMin. (DC500V)	
Electrical life	Alternate type	50,000cycles	
	Momentary type	25,000cycles	
Operating temperature range		-30~+85°C	
Storage temperature range		-40~+85°C	

(ON) : Momentary.

# 8B



RoHS Compliant



## Mustang Toggle Switch

### Features

The **8B** series is a sub-miniature toggle switch with a larger, rugged actuator and a larger bushing. Suitable for applications where panel space is limited and a larger toggle is needed.

### Table of Part Numbers

Terminal Style	Number of poles		1 pole	2 poles	3 poles	4 poles
	Switching Function					
Solder Terminal	ON — ON		8B1011-Z ▲ 8B1011C-Z	☆ 8B2011-Z ▲ 8B2011C-Z	☆ 8B3011-Z	★ 8B4011-Z
	ON — OFF — ON		★ 8B1021-Z ▲ 8B1021C-Z	★ 8B2021-Z ▲ 8B2021C-Z	▲ 8B3021-Z	★ 8B4021-Z
	(ON) — OFF — (ON)		★ 8B1041-Z	★ 8B2041-Z	—	—
	ON — OFF — (ON)		★ 8B1051-Z	▲ 8B2051-Z	—	—
	ON — (ON)		★ 8B1061-Z	★ 8B2061-Z	—	—
PC Straight	ON — ON		☆ 8B1012-Z ★ 8B1012C-Z	★ 8B2012-Z ▲ 8B2012C-Z	▲ 8B3012-Z	▲ 8B4012-Z
	ON — OFF — ON		▲ 8B1022-Z ▲ 8B1022C-Z	★ 8B2022-Z ▲ 8B2022C-Z	▲ 8B3022-Z	▲ 8B4022-Z
	(ON) — OFF — (ON)		▲ 8B1042-Z	▲ 8B2042-Z	—	—
	ON — OFF — (ON)		▲ 8B1052-Z	▲ 8B2052-Z	—	—
	ON — (ON)		▲ 8B1062-Z	▲ 8B2062-Z	—	—

- PC Hole Layouts ..... Page 414.
- Panel Cut-Out Dimensions ..... Page 414.
- Terminal Style ..... Page 387.
- Soldering, Flux Cleaning and Packing Spec. .... Page 413.

- Optional Accessories ..... Page 415.  
(Sold separately)

Color Cap		
Dimensions	Color	Part. No.
<p>Gloss finish Vinyl chloride resin</p>	White	140000470063
	Red	140000470108
	Black	140000470064
	Gray	140000470102

### Standard Accessories

〈Supplied with switch〉

Part Name	Hex Nut	Lockwasher	Locking Ring
Part No.	140008010243	140008030055	140008020065
Dimensions			
Finish	Nickel plated	Zinc plated	

SPDT

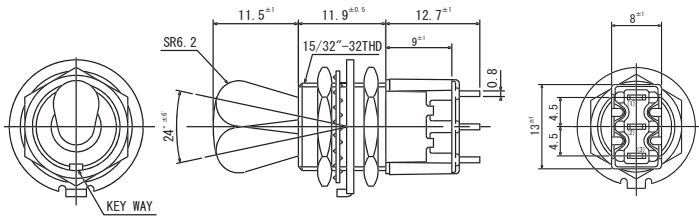

Terminal numbers are not shown on the switch.

Switching function	Key way	Key way	Key way
Part No.			
8B101■-Z	ON	—	ON
8B102■-Z	ON	OFF	ON
8B104■-Z	(ON)	OFF	(ON)
8B105■-Z	ON	OFF	(ON)
8B106■-Z	ON	—	(ON)
Connecting terminals	2-3	—	2-1

■ : Please refer to "Table of Part Numbers" on P.392 for a list of full part numbers.

DPDT

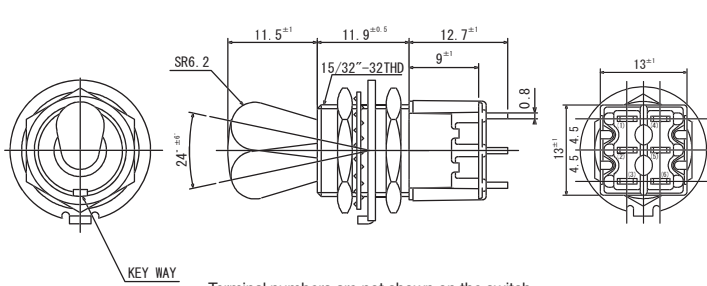

Terminal numbers are not shown on the switch.

Switching function	Key way	Key way	Key way
Part No.			
8B201■-Z	ON	—	ON
8B202■-Z	ON	OFF	ON
8B204■-Z	(ON)	OFF	(ON)
8B205■-Z	ON	OFF	(ON)
8B206■-Z	ON	—	(ON)
Connecting terminals	2-3 5-6	—	2-1 5-4

■ : Please refer to "Table of Part Numbers" on P.392 for a list of full part numbers.

3PDT

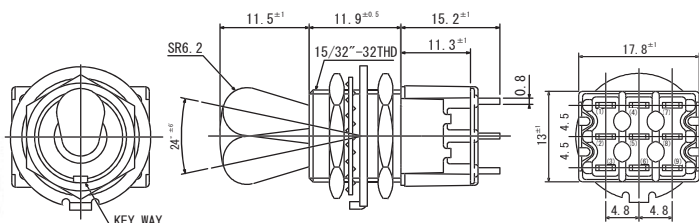

Terminal numbers are not shown on the switch.

Switching function	Key way	Key way	Key way
Part No.			
8B301■-Z	ON	—	ON
8B302■-Z	ON	OFF	ON
Connecting terminals	2-3 5-6 8-9	—	2-1 5-4 8-7

■ : Please refer to "Table of Part Numbers" on P.392 for a list of full part numbers.

4PDT

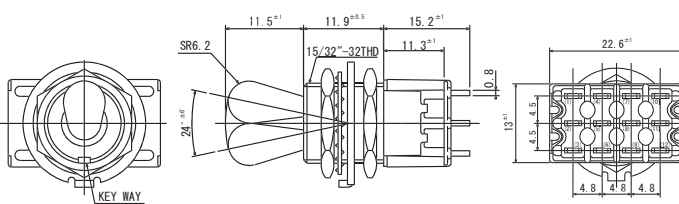

Terminal numbers are not shown on the switch.

Switching function	Key way	Key way	Key way
Part No.			
8B401■-Z	ON	—	ON
8B402■-Z	ON	OFF	ON
Connecting terminals	2-3 5-6 8-9 11-12	—	2-1 5-4 8-7 11-10

■ : Please refer to "Table of Part Numbers" on P.392 for a list of full part numbers.

## ■Precautions (8A • 8B • 8C • 8D • 8E • 8F • 8J • 8S • 8SS)

### 1. Soldering Specifications

(1)Manual soldering

Device : Solder iron

①420°C Max. 3 sec. Max.

(2)Auto soldering

②275°C Max. 6 sec. Max.

The above-stated soldering conditions shall apply only to switches with straight terminals. Auto soldering is not possible with right-angle terminals. Switches with right-angle terminals should be soldered manually according to the conditions specified in (1) above.

(3)When soldering two or more terminals to the common land, use the solder resist to isolate the terminals.

### 3. Mounting

- Do not bend the terminals before mounting the switch on the PC board.
- After mounting the switch, do not place the device in such a way that the device weight will be applied on to the actuator of the switch.
- For switches with straight terminals, solder the switch on the PC board after fixing the switch on the panel with a nut.

### 2.Flux Cleaning

(1)Solvent : Fluorine or Alcohol type.

(2)**8A/B/C/D/E/F/J/S** series are not washable. To wash the PC board, clean the soldering surface of the PC board with a brush so that the switch is not exposed to the cleaning solution.

(3)Cleaning after soldering should be done after the terminal temperature falls to 90°C or below, or after leaving the switch for five minutes or longer at room temperature.

## ■Packaging Specification

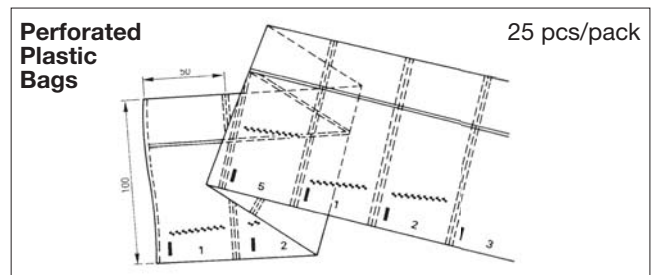

(ON) : Momentary.

# ◆ 8 Series Toggles ◆

## ■ Panel Cut-Out Dimensions

Series	8A·8D·8J·8S	8C	8E	8A·8D·8J·8S	8C	8E	8F
Panel thickness	2.5 mm Max.	2.4 mm Max.	1.5 mm Max.	3.5 mm Max.	3.4 mm Max.	2.5 mm Max.	5 mm Max.
Dimensions	<p style="text-align: center;">With Locking Ring</p>			<p style="text-align: center;">Without Locking Ring</p>			
Series	<b>8B</b>						
Panel thickness	5.9 mm Max.			6.9 mm Max.			
Dimensions	<p style="text-align: center;">With Locking Ring</p>			<p style="text-align: center;">Without Locking Ring</p>			

## ■ PC Hole Layouts

Series	8A · 8B · 8C · 8D · 8E · 8F · 8J · 8S
Dimensions	<p style="text-align: center;">1-pole 2-pole</p>

## ■ Standard Accessories

Part Name	(Q'ty / switch)							
	Dress Nut	Hex Nut	Lockwasher	Locking Ring	O-Ring	Hex Nut	Lockwasher	Locking Ring
Part No.	140008010253	140008010241	140008030051	140008020062	14000610076	140008010243	140008030055	140008020065
Dimensions								
Finish	Nickel plated		Zinc plated		Nitrile rubber (Black)	Nickel plated	Zinc plated	
8A		2	1	1				
8B						2	1	1
8C	1	1	1	1				
8D		2	1	1				
8E		2	1	1				
8F		1	1		1			
8J		2	1	1				
8S		2	1	1				

● Numbers in the above chart show the quantities of each accessories enclosed with the switch.

**Optional Accessories**

《Sold separately》

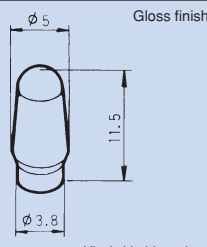
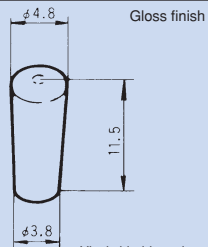
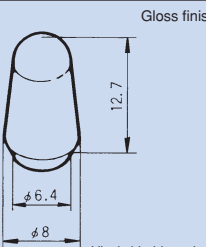
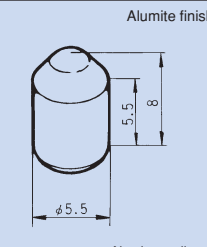
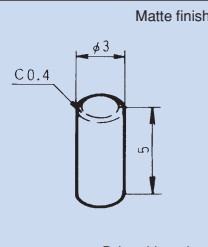
Type	8A · 8F · 8GA BT	8A · 8F · 8GA BT	8B	8E	8S · 8GS
Part Name	Color Cap				Color Tip
Dimensions					
Silver	—	—	—	<b>140000470058</b>	—
White	<b>140000470030</b>	<b>140000470038</b>	<b>140000470063</b>	—	<b>140000470118</b>
Red	<b>140000470098</b>	<b>140000470100</b>	<b>140000470108</b>	<b>140000470060</b>	<b>140000470119</b>
Black	<b>140000470031</b>	<b>140000470039</b>	<b>140000470064</b>	<b>140000470059</b>	<b>140000470112</b>
Gray	<b>140000470037</b>	<b>140000470077</b>	<b>140000470102</b>	—	<b>140000470120</b>

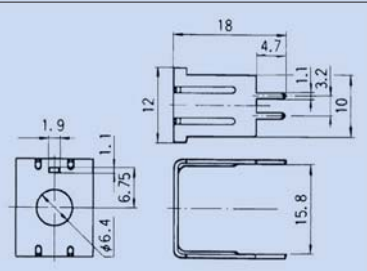
Type	<b>8A · 8C · 8D · 8J · 8S</b> 1, 2 poles*
Part Name	<b>Bracket</b>
Part No.	<b>140000260715</b>
Dimensions	

※The Bracket cannot be used with switches with switching functions "10", "11", or "12" (ref. P.388). The size of the housings are different in switches with switching functions "10", "11", and "12" and the Bracket cannot be used.

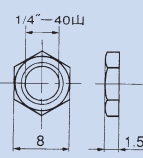
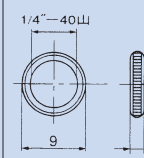
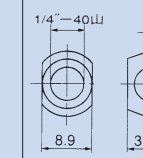
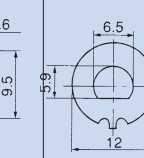
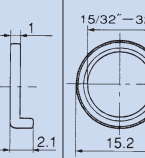
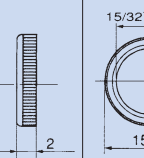
Type	8A · 8C · 8D · 8E · 8J · 8N · 8S · 8R			8F · 8P	8B · 8Y	
Part Name	Lock Nut	Round Nut	Pocketed Nut	Locking Ring	Round Nut	Round Nut
Part No.	<b>140008010276</b>	<b>140008010258</b>	<b>140008010274</b>	<b>140008020066</b>	<b>140008010272</b>	<b>140008010273</b>
Dimensions						
Finish	Nickel	Chromium	Nickel	Zinc	Chromium	

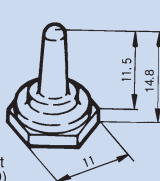
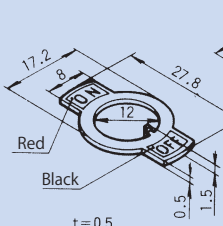
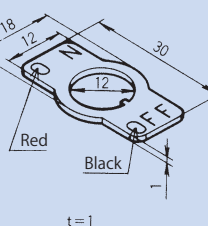
Type	8A	8B	
Part Name	Boot	Plate	Plate
Part No.	<b>140000470422</b>	<b>140008040021</b>	<b>140008040025</b>
Dimensions			



# Table of 8 Series Toggles UL and CSA Listed

## 8 Series Toggles

Poles	Switching Function			UL (※1.)								CSA (※2.)							
				8A	8B	8C	8D	8E	8F	8J	8S	8A	8B	8C	8D	8E	8F	8J	8S
1 pole	101□	ON	—	ON	○	○	○	○	○	○	○	○	○	○	○	○	○	○	○
	102□	ON	—	OFF	—	ON	○	○	○	○	○	○	○	○	○	○	○	○	○
	104□	(ON)	—	OFF	—	(ON)	○	○	○	○	○	○	○	○	○	○	○	○	○
	105□	ON	—	OFF	—	(ON)	○	○	○	○	○	○	○	○	○	○	○	○	○
	106□	ON	—	(ON)	○	○	○	○	○	○	○	○	○	○	○	○	○	○	○
2 poles	201□	ON	—	ON	○	○	○	○	○	○	○	○	○	○	○	○	○	○	○
	202□	ON	—	OFF	—	ON	○	○	○	○	○	○	○	○	○	○	○	○	○
	204□	(ON)	—	OFF	—	(ON)	○	○	○	○	○	○	○	○	○	○	○	○	○
	205□	ON	—	OFF	—	(ON)	○	○	○	○	○	○	○	○	○	○	○	○	○
	206□	ON	—	(ON)	○	○	○	○	○	○	○	○	○	○	○	○	○	○	○
	210□	ON	—	ON	—	ON	○							○					
	211□	ON	—	ON	—	(ON)	○							○					
212□	(ON)	—	ON	—	(ON)	○							○						
3 poles	301□	ON	—	ON	○	○	○	○	○	○	○	○	○	○	○	○	○	○	○
	302□	ON	—	OFF	—	ON	○	○	○	○	○	○	○	○	○	○	○	○	○
	304□	(ON)	—	OFF	—	(ON)	○	○	○	○	○	○	○	○	○	○	○	○	○
	305□	ON	—	OFF	—	(ON)	○	○	○	○	○	○	○	○	○	○	○	○	○
	306□	ON	—	(ON)	○	○	○	○	○	○	○	○	○	○	○	○	○	○	○
4 poles	401□	ON	—	ON	○	○	○	○	○	○	○	○	○	○	○	○	○	○	○
	402□	ON	—	OFF	—	ON	○	○	○	○	○	○	○	○	○	○	○	○	○
	404□	(ON)	—	OFF	—	(ON)	○	○	○	○	○	○	○	○	○	○	○	○	○
	405□	ON	—	OFF	—	(ON)	○	○	○	○	○	○	○	○	○	○	○	○	○
	406□	ON	—	(ON)	○	○	○	○	○	○	○	○	○	○	○	○	○	○	○
	410□	ON	—	ON	—	ON	○							○					
	411□	ON	—	ON	—	(ON)	○							○					
	412□	(ON)	—	ON	—	(ON)	○							○					

(1) Terminal types:  Solder terminal;  Straight terminal

(2) **UL**-recognized switches: Solder terminals and straight terminals available for Single/Double/Three/Four Pole

(3) **CSA**-certified switches: Solder terminals and straight terminals available for Single Pole. Straight terminals available for Double/Three/Four Pole.

(4) UL, CSA marked switches available with additional charge.

(5) (※1.) **UL File No.E43275**  
(※2.) **CSA File No.JR38341**

(6) As shown in the above chart, not all products are **UL**-recognized or **CSA**-certified. Please check with your local sales representative if you have any questions.