

REV.	ECN NO.	REVISIONS	DRN.	CKD.	APP.	DATE
A	—	NEW RELEASE	YIS	JMC	NO	6-9-03
B	—	REDESIGNED LIGHTPIPE	YIS			

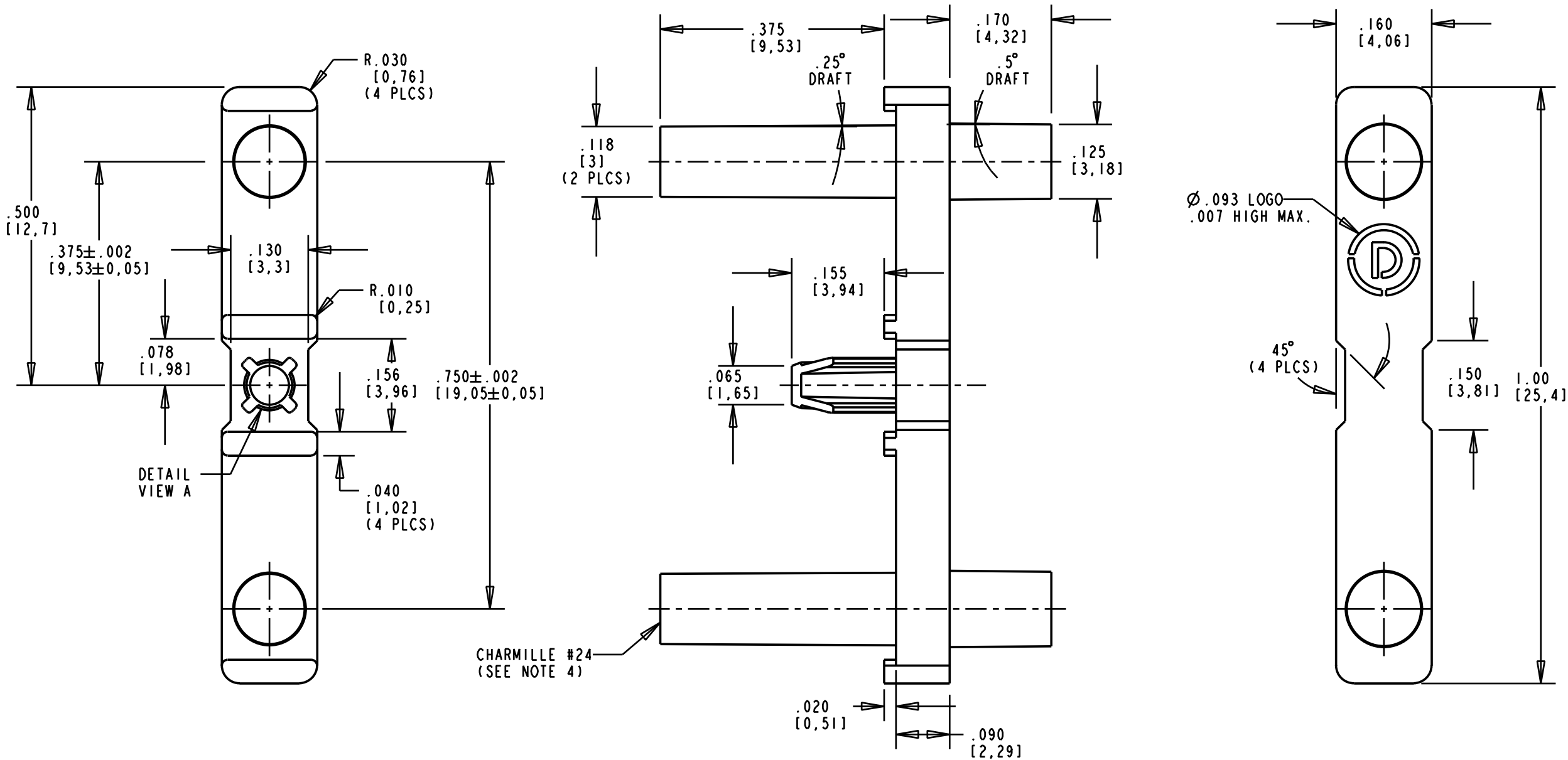

NOTES:

1. KNOCKOUT PROJECTIONS OR RECESSES NOT TO EXCEED  $.005$ .
2. FLASH NOT TO EXCEED  $.003$ .
3. SINK MARKS NOT TO EXCEED  $.005$  UNLESS OTHERWISE SPECIFIED.
4. NO BUBBLES IN CRITICAL LIGHTPATH GREATER THAN  $.005$ ".
5. UNLESS OTHERWISE SPECIFIED, ALL SURFACES MUST HAVE FINISH OF SPI A2 TO B1.
6. DIALIGHT LIGHTPIPE PART NUMBER: 515-1133.

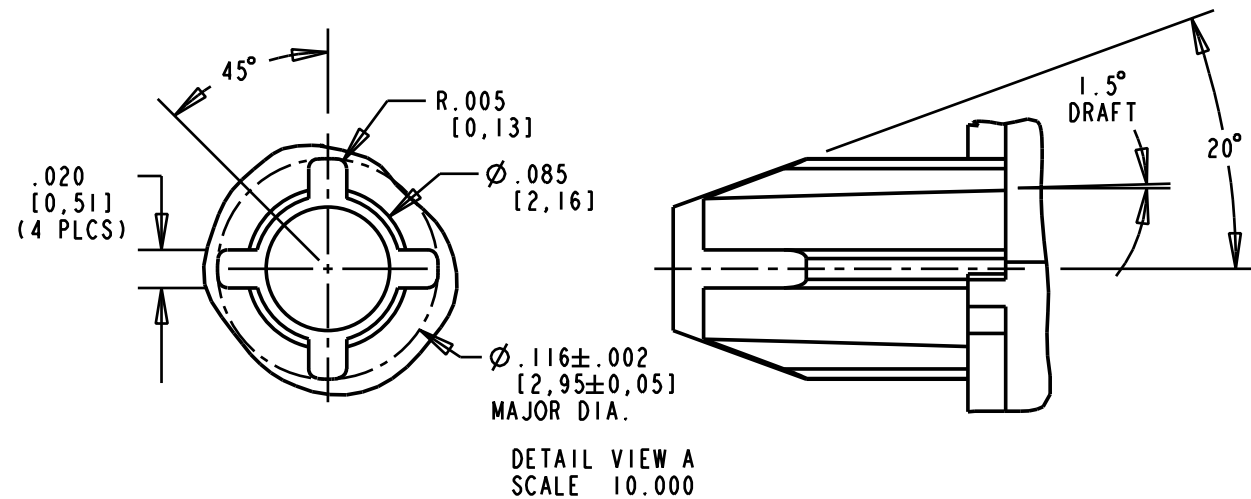

THIS DRAWING AND THE CONTENTS HEREIN ARE CONFIDENTIAL AND THE SOLE PROPERTY OF DIALIGHT. REPRODUCTION OF THIS DRAWING OR CONSTRUCTION OF ANY PARTS WITHIN THIS DRAWING ARE FORBIDDEN WITHOUT THE WRITTEN CONSENT OF DIALIGHT.

SCALE: 5.000	DRAWING NUMBER	REV
ALL DIM'S IN: INCHES (MM)	C-17067	B
TOLERANCES: UNLESS OTHERWISE SPECIFIED	TITLE	
FRACTIONS: $\pm 1/64$	2 ELEMENT STRAIGHT LIGHT PIPE	
DECIMALS (.XX): $\pm .01$	MATERIAL	
DECIMALS (.XXX): $\pm .005$	9000-000-6407-04	
DECIMALS (.XXXX): $\pm .0005$	FINISH:	
ANGLES: $\pm 1^\circ$	Dialight	
	1501 ROUTE 34 SOUTH FARMINGDALE, NJ 07727	
FSCM 83330	SHEET OF	FAMILY TABLE: