

THIS DOCUMENT IS THE PROPERTY OF
KEYSTONE ELECTRONICS CORP. AND
SHALL NOT BE REPRODUCED, DISTRIBUTED
OR USED AS A BASIS FOR MANUFACTURE
WITHOUT PRIOR WRITTEN PERMISSION
FROM KEYSTONE ELECTRONICS CORP.

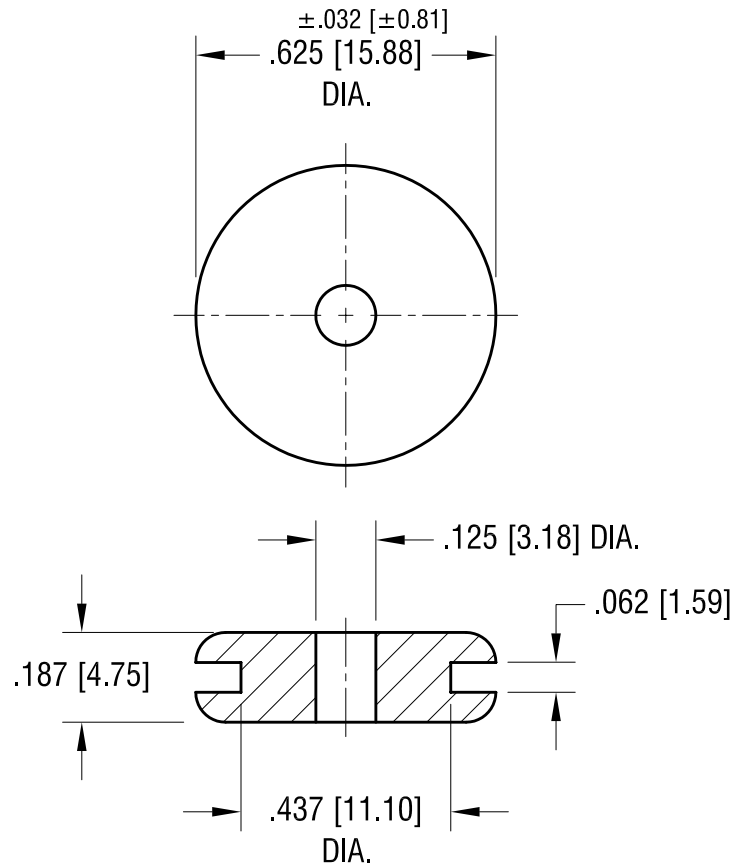

KEYSTONE ELECTRONICS CORP.

ASTORIA, N.Y. 11105-2017

PART NAME

RUBBER GROMMET

MATERIAL

BUNA N

FINISH

-

DRN BY

BOONE

DATE

10.10.97

APP'D

LN

SCALE

2.5X

1.02.08

CHANGE AS PER ECN 08-012

A

TOLERANCES

INCH [MM]

DECIMAL $\pm .020$ [± 0.50]

ANGULAR $\pm 1^\circ$
UNLESS OTHERWISE SPECIFIED

CODE

C/M

DWG NO.

734

DATE

DESCRIPTION

REV.