

VAL-SQ SI 50-120/240S

Order No.: 2800323



<http://eshop.phoenixcontact.de/phoenix/treeViewClick.do?UID=2800323>

50 kA surge protection device for 120/240 V AC single/split phase configurations with separate Gnd and N conductors. Uses a compact, NEMA 4X-rated enclosure that connects easily to an existing enclosure.

Commercial data	
GTIN (EAN)	 4 046356 564915
Note	Made-to-order
sales group	J103
Pack	1 pcs.
Customs tariff	85363090
Catalog page information	Page 78 (TT-2011)

Product notes

WEEE/RoHS-compliant since:
02/21/2010



<http://www.download.phoenixcontact.com>
Please note that the data given here has been taken from the online catalog. For comprehensive information and data, please refer to the user documentation. The General Terms and Conditions of Use apply to Internet downloads.

Product description

50 kA Type 1 surge protective device for single and split phase systems with separate Gnd and N

Technical data

Standards

Housing material	Non-metallic
Degree of protection	NEMA 4X
Mounting type	1/2 inch NPT male
Design	MOV
Ambient temperature (operation)	-40 °C ... 70 °C
Altitude	3658 m
Message: Surge protection fault	Optical
Width	76.00 mm
Height	91.00 mm

Protective circuit

Arrester rated voltage U_c	150 V
------------------------------	-------

Connection, protective circuit

Connection method	#12 AWG wires / 24 in. (61 cm)
-------------------	--------------------------------

NEMA / UL data

UL type	type 1
Nominal discharge current I_n (without reference direction)	10 kA
Maximum Surge Current per Phase	50 kA
Short-circuit current rating (SCCR)	25 kA

Environmental conditions

Standards/regulations	UL 1449 3 rd edition, Sept. 2009
	UL 1283
	IEEE C62.41
	IEEE C62.45

Diagrams/Drawings

Circuit diagram

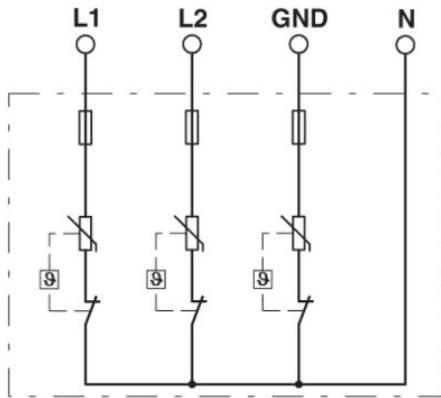

Address

PHOENIX CONTACT Inc., USA
586 Fulling Mill Road
Middletown, PA 17057, USA
Phone (800) 888-7388
Fax (717) 944-1625
<http://www.phoenixcon.com>



© 2011 Phoenix Contact
Technical modifications reserved;