

# Assembly Instructions for - 37297

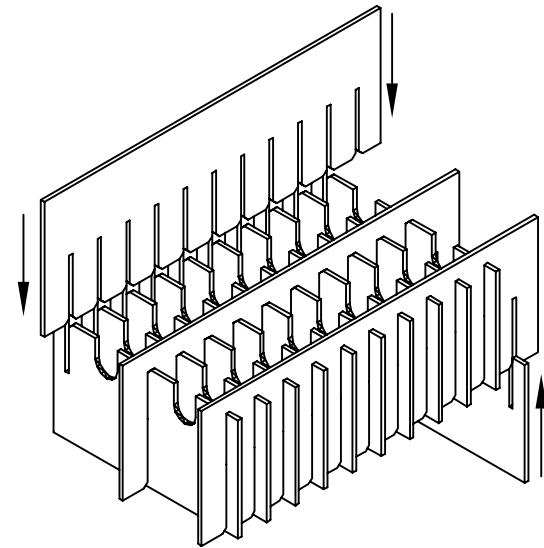
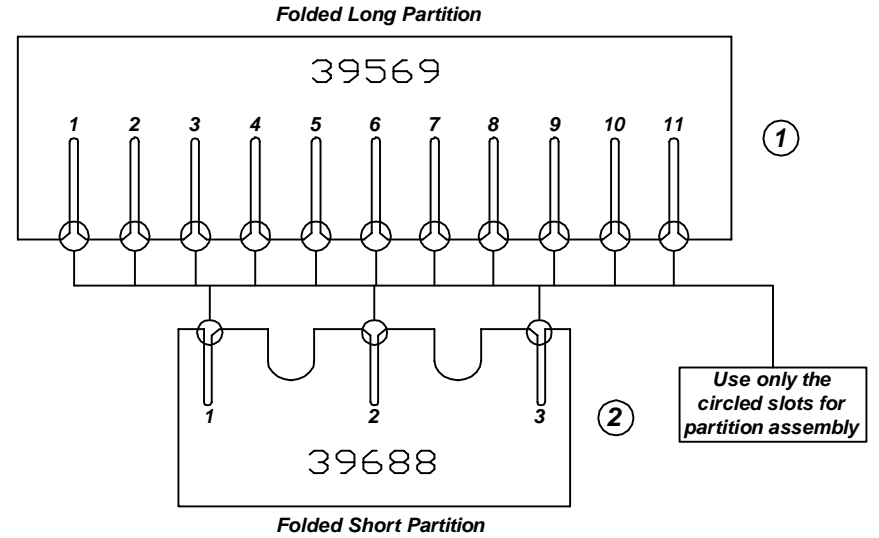
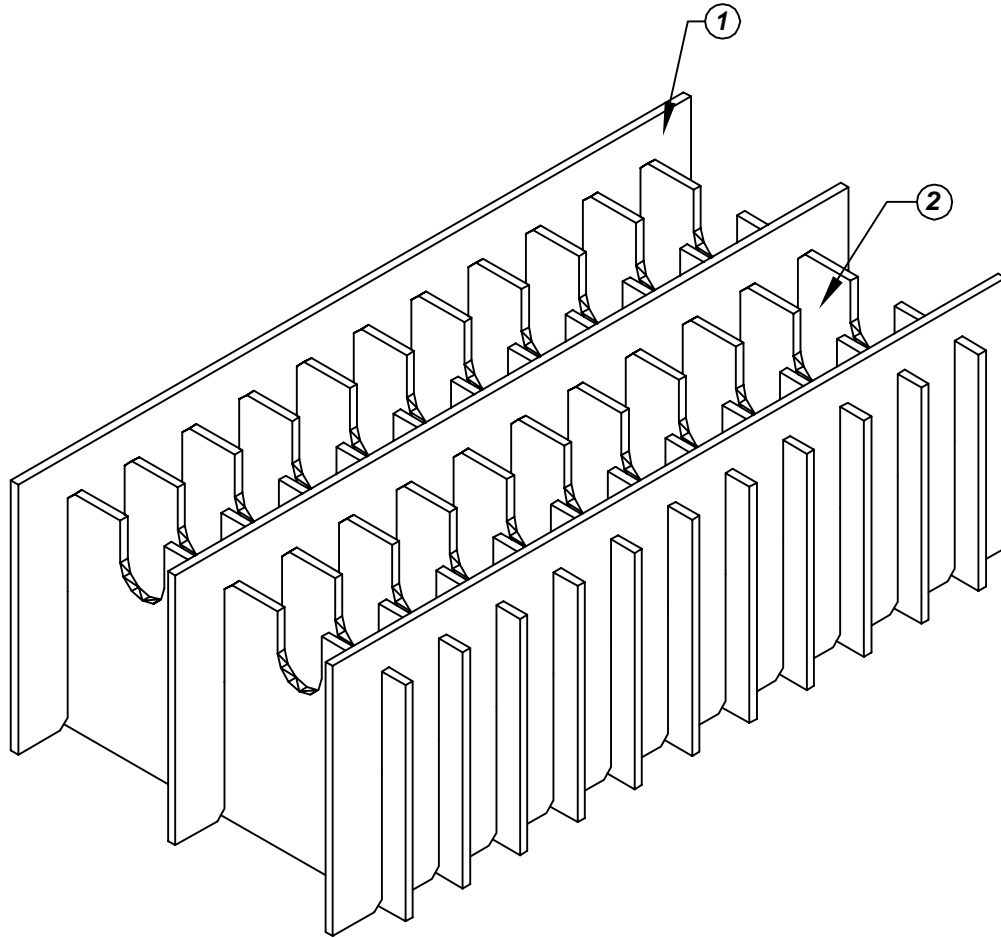

Made in America

F/N ①	Part # 39569	Dimensions: 16-1/4" x 23"	Description: 448-HLP Long Partition	Qty: 3
F/N ②	Part # 39688	Dimensions: 14-1/4" x 12-5/8"	Description: 448-HSP Short Partition	Qty: 11

Notes:  
For use with the following storage container & lid:  
37517 - Storage Container  
37552 - Lid

PROTEKTIVE PAK  
13520 MONTE VISTA AVENUE, CHINO, CA 91710  
PHONE (909) 627-2578, FAX (909) 363-7331  
ProtectivePak.com

**PROTEKTIVE PAK**  
BURIED CONDUCTIVE LAYER

DRAWING NUMBER  
**IPH-37297**

DATE  
Nov.  
2007

**37297 - 24 Cell Inplant Handler**  
**Cell Size - 8" x 5-3/16" x 1-5/8"**