

Insulated Gate Bipolar Transistor (Ultrafast IGBT), 90 A

SOT-227

**RoHS
COMPLIANT**
FEATURES

- NPT Gen 5 IGBT technology
- Square RBSOA
- HEXFRED® low Q_{rr} , low switching energy
- Positive $V_{CE(on)}$ temperature coefficient
- Fully isolated package
- Very low internal inductance (≤ 5 nH typical)
- Industry standard outline
- UL approved file E78996
- Material categorization: for definitions of compliance please see www.vishay.com/doc?99912

BENEFITS

- Designed for increased operating efficiency in power conversion: UPS, SMPS, welding, induction heating
- Easy to assemble and parallel
- Direct mounting on heatsink
- Plug-in compatible with other SOT-227 packages
- Low EMI, requires less snubbing

PRODUCT SUMMARY

V_{CES}	1200 V
I_C DC	90 A at 90 °C
$V_{CE(on)}$ typical at 75 A, 25 °C	3.3 V
Speed	8 kHz to 30 kHz
Package	SOT-227
Circuit	Single switch diode

ABSOLUTE MAXIMUM RATINGS

PARAMETER	SYMBOL	TEST CONDITIONS	MAX.	UNITS
Collector to emitter voltage	V_{CES}		1200	V
Continuous collector current	I_C ⁽¹⁾	$T_C = 25$ °C	149	A
		$T_C = 90$ °C	90	
Pulsed collector current	I_{CM}		200	
Clamped inductive load current	I_{LM}		200	
Diode continuous forward current	I_F	$T_C = 25$ °C	76	V
		$T_C = 90$ °C	46	
Gate to emitter voltage	V_{GE}		± 20	V
Power dissipation, IGBT	P_D	$T_C = 25$ °C	862	W
		$T_C = 90$ °C	414	
Power dissipation, diode	P_D	$T_C = 25$ °C	357	
		$T_C = 90$ °C	171	
Isolation voltage	V_{ISOL}	Any terminal to case, $t = 1$ min	2500	V

Note

⁽¹⁾ Maximum collector current admitted is 100 A, to do exceed the maximum temperature of terminals



ELECTRICAL SPECIFICATIONS (T _J = 25 °C unless otherwise specified)						
PARAMETER	SYMBOL	TEST CONDITIONS	MIN.	TYP.	MAX.	UNITS
Collector to emitter breakdown voltage	V _{BR(CES)}	V _{GE} = 0 V, I _C = 250 μA	1200	-	-	
Collector to emitter voltage	V _{CE(on)}	V _{GE} = 15 V, I _C = 75 A	-	3.3	3.8	V
		V _{GE} = 15 V, I _C = 75 A, T _J = 125 °C	-	3.6	3.9	
		V _{GE} = 15 V, I _C = 75 A, T _J = 150 °C	-	3.7	-	
Gate threshold voltage	V _{GE(th)}	V _{CE} = V _{GE} , I _C = 250 μA	4	5	6	
		V _{CE} = V _{GE} , I _C = 250 μA, T _J = 125 °C	-	3.2	-	
Temperature coefficient of threshold voltage	V _{GE(th)} /ΔT _J	V _{CE} = V _{GE} , I _C = 1 mA (25 °C to 125 °C)	-	-12	-	mV/°C
Collector to emitter leakage current	I _{CES}	V _{GE} = 0 V, V _{CE} = 1200 V	-	7	250	μA
		V _{GE} = 0 V, V _{CE} = 1200 V, T _J = 125 °C	-	1.4	10	mA
		V _{GE} = 0 V, V _{CE} = 1200 V, T _J = 150 °C	-	6.5	20	
Forward voltage drop, diode	V _{FM}	V _{GE} = 0 V, I _F = 75 A	-	3.4	5.0	V
		V _{GE} = 0 V, I _F = 75 A, T _J = 125 °C	-	3.2	5.2	
		V _{GE} = 0 V, I _F = 75 A, T _J = 150 °C	-	3.05	-	
Gate to emitter leakage current	I _{GES}	V _{GE} = ± 20 V	-	-	± 250	nA

SWITCHING CHARACTERISTICS (T _J = 25 °C unless otherwise specified)							
PARAMETER	SYMBOL	TEST CONDITIONS	MIN.	TYP.	MAX.	UNITS	
Total gate charge (turn-on)	Q _g	I _C = 50 A, V _{CC} = 600 V, V _{GE} = 15 V	-	690	-	nC	
Gate to emitter charge (turn-on)	Q _{ge}		-	65	-		
Gate to collector charge (turn-on)	Q _{gc}		-	250	-		
Turn-on switching loss	E _{on}	I _C = 75 A, V _{CC} = 600 V, V _{GE} = 15 V, R _g = 5 Ω, L = 500 μH, T _J = 25 °C	-	1.2	-	mJ	
Turn-off switching loss	E _{off}		-	2.1	-		
Total switching loss	E _{tot}		-	3.3	-		
Turn-on delay time	t _{d(on)}		Energy losses include tail and diode recovery Diode used HFA16PB120	-	250	-	ns
Rise time	t _r			-	38	-	
Turn-off delay time	t _{d(off)}			-	280	-	
Fall time	t _f	-		90	-	mJ	
Turn-on switching loss	E _{on}	-		1.7	-		
Turn-off switching loss	E _{off}	-		4.08	-		
Total switching loss	E _{tot}	I _C = 75 A, V _{CC} = 600 V, V _{GE} = 15 V, R _g = 5 Ω, L = 500 μH, T _J = 125 °C	-	5.78	-	ns	
Turn-on delay time	t _{d(on)}		-	245	-		
Rise time	t _r		-	48	-		
Turn-off delay time	t _{d(off)}		-	280	-		
Fall time	t _f		-	140	-		
Reverse bias safe operating area	RBSOA	T _J = 150 °C, I _C = 200 A, R _g = 22 Ω, V _{GE} = 15 V to 0 V, V _{CC} = 900 V, V _P = 1200 V, L = 500 μH	Fullsquare				
Diode reverse recovery time	t _{rr}	I _F = 50 A, dI _F /dt = 200 A/μs, V _R = 200 V	-	140	-	ns	
Diode peak reverse current	I _{rr}		-	13	-	A	
Diode recovery charge	Q _{rr}		-	860	-	nC	
Diode reverse recovery time	t _{rr}	I _F = 50 A, dI _F /dt = 200 A/μs, V _R = 200 V, T _J = 125 °C	-	210	-	ns	
Diode peak reverse current	I _{rr}		-	19	-	A	
Diode recovery charge	Q _{rr}		-	1880	-	nC	



THERMAL AND MECHANICAL SPECIFICATIONS						
PARAMETER	SYMBOL	TEST CONDITIONS	MIN.	TYP.	MAX.	UNITS
Junction and storage temperature range	T_J, T_{Stg}		-40	-	150	°C
Junction to case	IGBT		-	-	0.145	°C/W
	Diode		-	-	0.35	
Case to heatsink	R_{thCS}	Flat, greased surface	-	0.05	-	
Weight			-	30	-	g
Mounting torque		Torque to terminal	-	-	1.1 (9.7)	Nm (lbf.in)
		Torque to heatsink	-	-	1.3 (11.5)	Nm (lbf.in)
Case style	SOT-227					

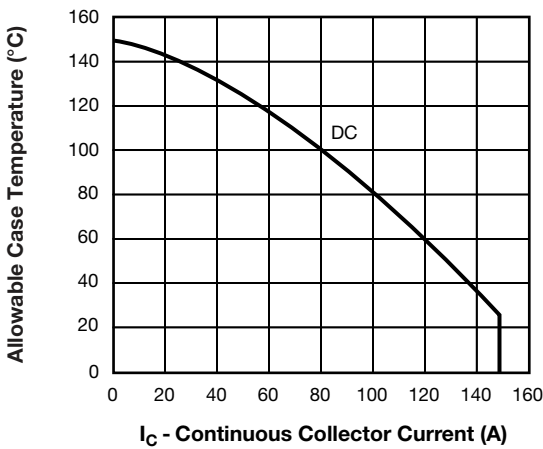

Fig. 1 - Maximum DC IGBT Collector Current vs. Case Temperature

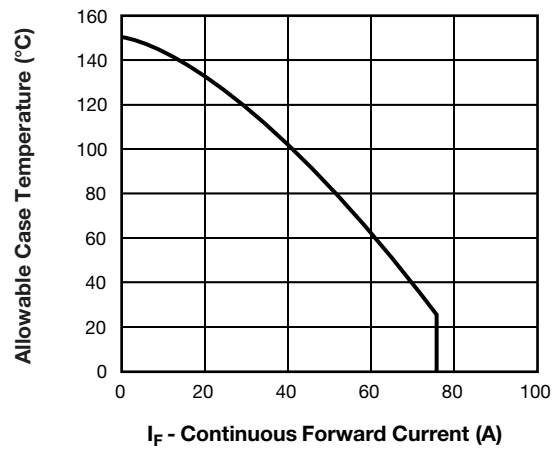

Fig. 3 - Allowable Forward Current vs. Case Temperature Diode Leg

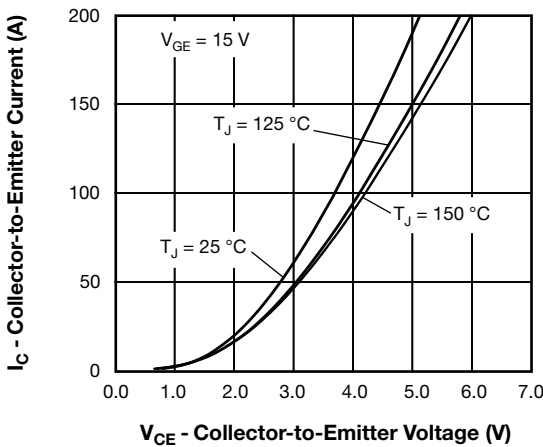

Fig. 2 - Typical Collector to Emitter Current Output Characteristics of IGBT

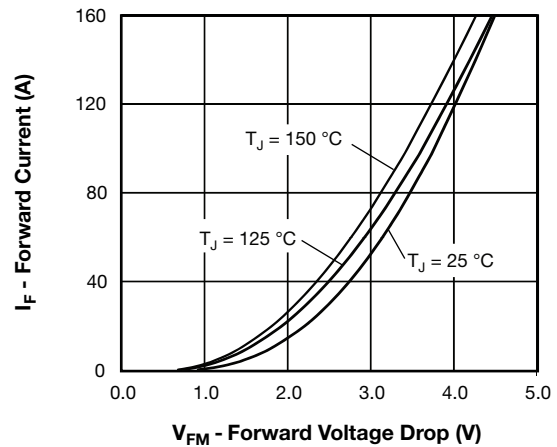

Fig. 4 - Typical Diode Forward Voltage Drop Characteristics

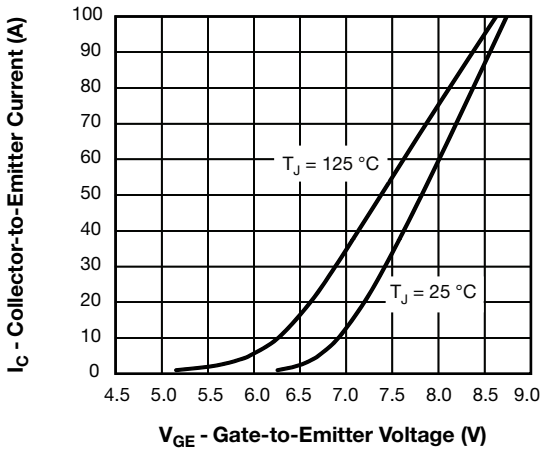

Fig. 5 - Typical IGBT Transfer Characteristics

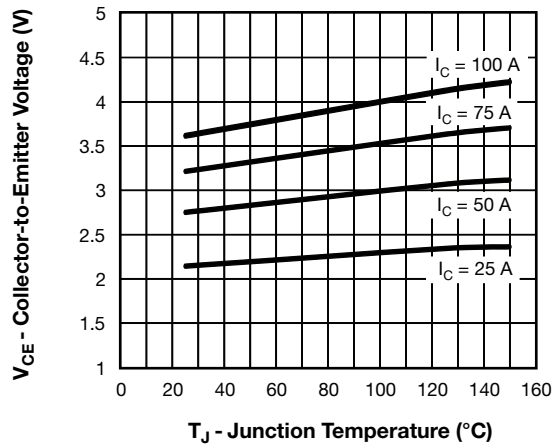

Fig. 8 - Typical IGBT Collector to Emitter Voltage vs. Junction Temperature, $V_{GE} = 15\text{ V}$

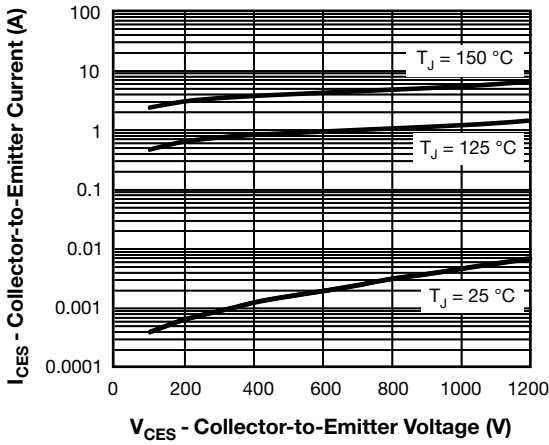

Fig. 6 - Typical IGBT Zero Gate Voltage Collector Current

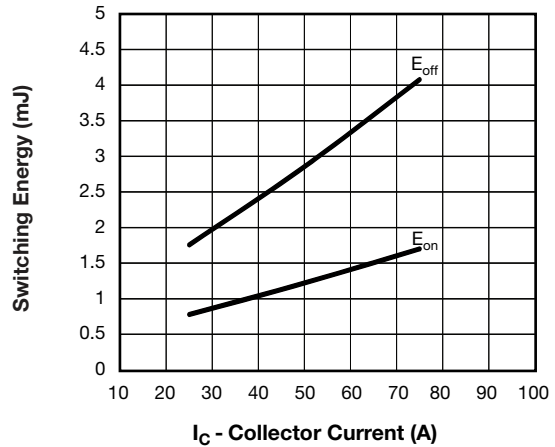

Fig. 9 - Typical IGBT Energy Losses vs. I_C
 $T_J = 125\text{ }^\circ\text{C}$, $L = 500\text{ }\mu\text{H}$, $V_{CC} = 600\text{ V}$,
 $R_g = 5\text{ }\Omega$, $V_{GE} = 15\text{ V}$, Diode used HFA16PB120

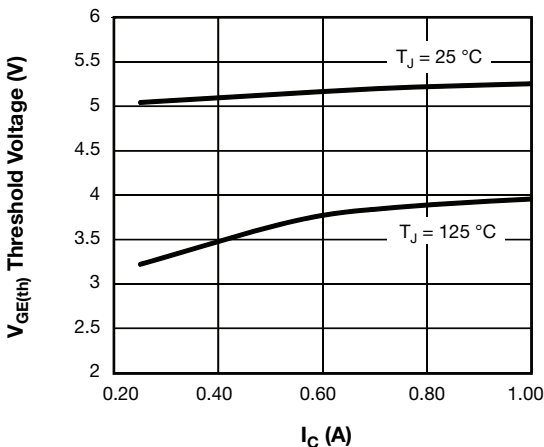

Fig. 7 - Typical IGBT Threshold Voltage

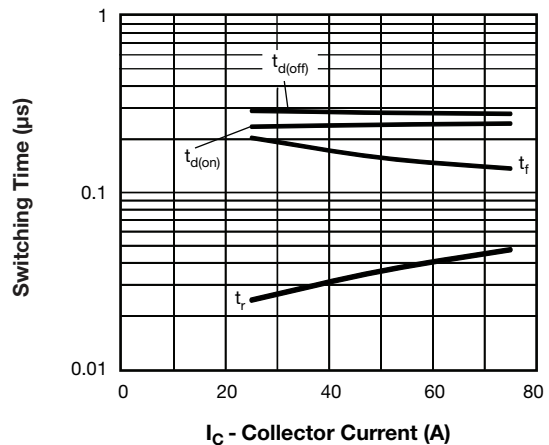

Fig. 10 - Typical IGBT Switching Time vs. I_C
 $T_J = 125\text{ }^\circ\text{C}$, $L = 500\text{ }\mu\text{H}$, $V_{CC} = 600\text{ V}$,
 $R_g = 5\text{ }\Omega$, $V_{GE} = 15\text{ V}$, Diode used HFA16PB120

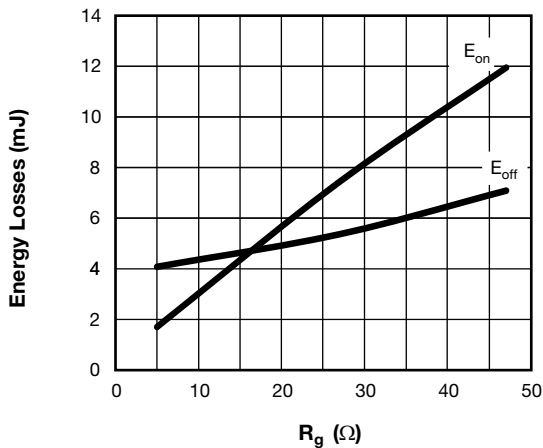

Fig. 11 - Typical IGBT Energy Loss vs. R_g ,
 $T_J = 125\text{ }^\circ\text{C}$, $I_C = 75\text{ A}$, $L = 500\text{ }\mu\text{H}$,
 $V_{CC} = 600\text{ V}$, $V_{GE} = 15\text{ V}$, Diode used HFA16PB120

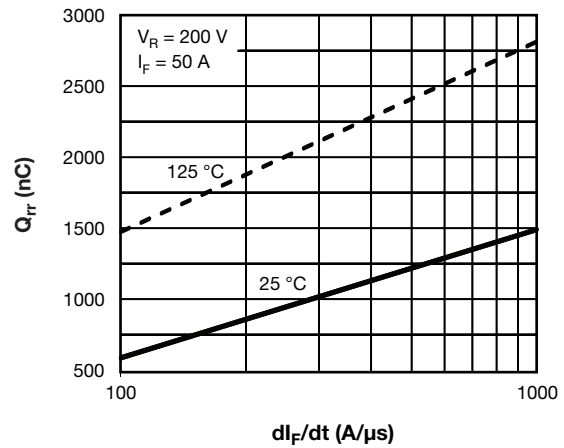

Fig. 14 - Stored Charge vs. di_F/dt of Diode

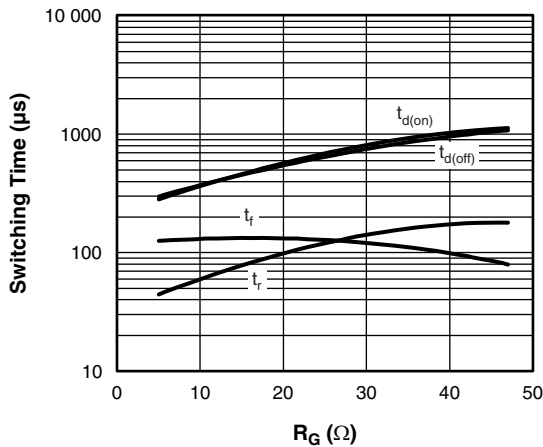

Fig. 12 - Typical IGBT Switching Time vs. R_g ,
 $T_J = 125\text{ }^\circ\text{C}$, $L = 500\text{ }\mu\text{H}$, $V_{CC} = 600\text{ V}$,
 $R_g = 5\text{ }\Omega$, $V_{GE} = 15\text{ V}$

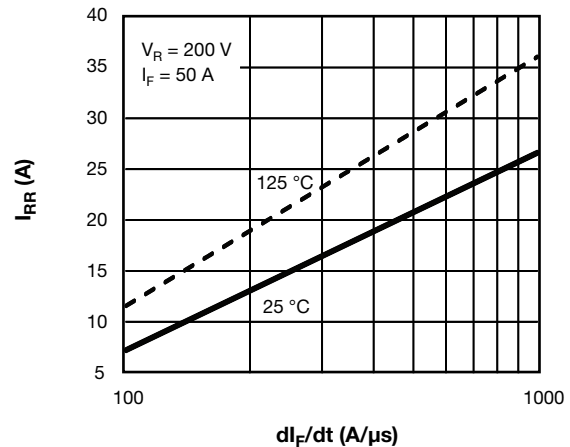

Fig. 15 - Typical Reverse Recovery Current vs. di_F/dt of Diode

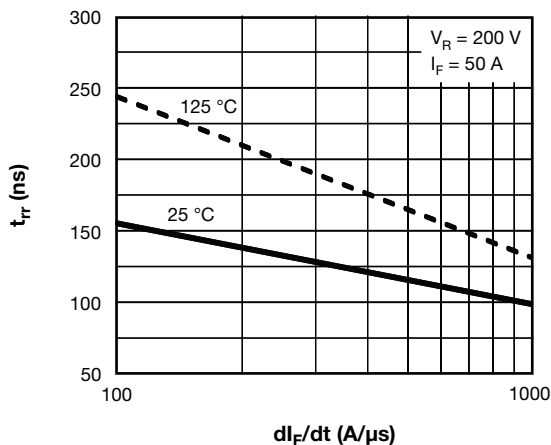

Fig. 13 - Typical t_{rr} Diode vs. di_F/dt
 $V_{RR} = 200\text{ V}$, $I_F = 50\text{ A}$

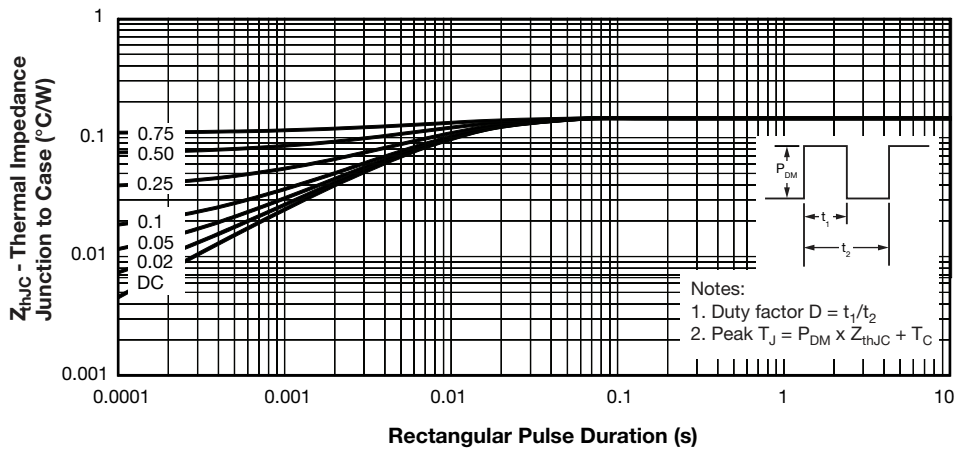

Fig. 16 - Maximum Thermal Impedance Z_{thJC} Characteristics (IGBT)

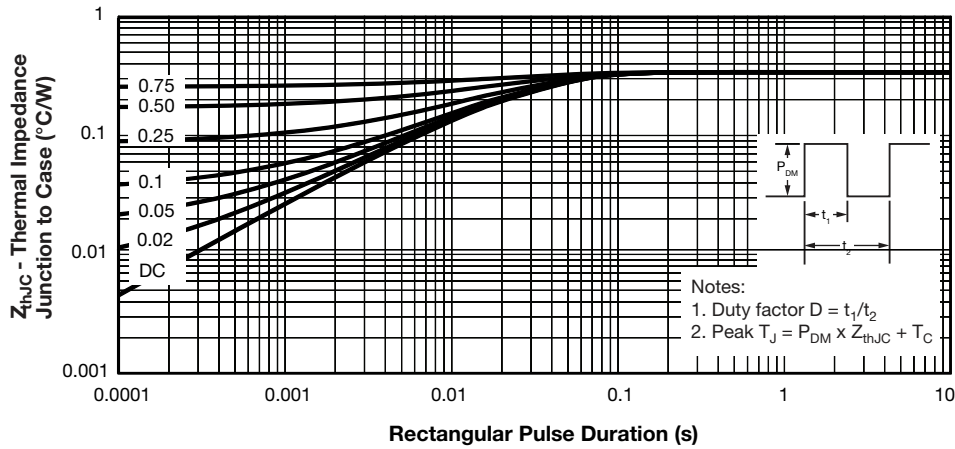

Fig. 17 - Maximum Thermal Impedance Z_{thJC} Characteristics (Diode)

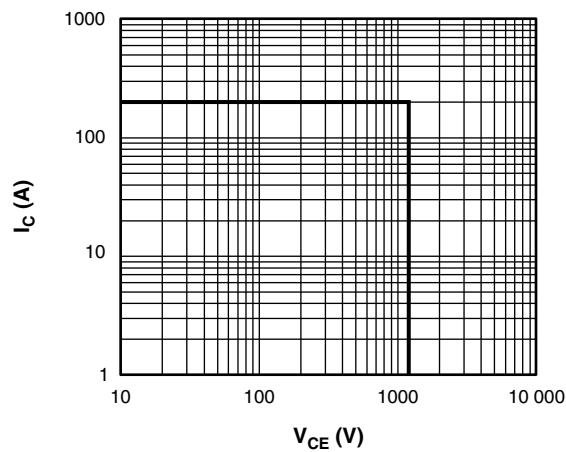

Fig. 18 - IGBT Reverse Bias SOA, $T_J = 150\text{ }^\circ\text{C}$, $V_{GE} = 15\text{ V}$,

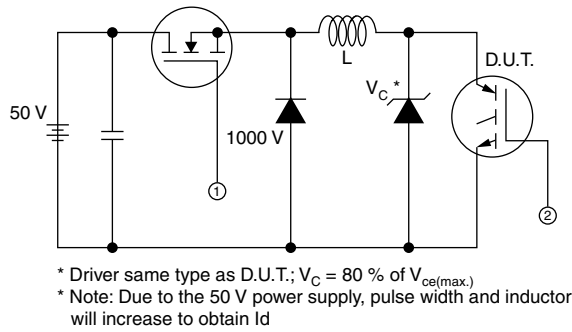

Fig. 19a - Clamped Inductive Load Test Circuit

* Driver same type as D.U.T.; $V_C = 80\%$ of $V_{ce(max)}$
 * Note: Due to the 50 V power supply, pulse width and inductor will increase to obtain I_d

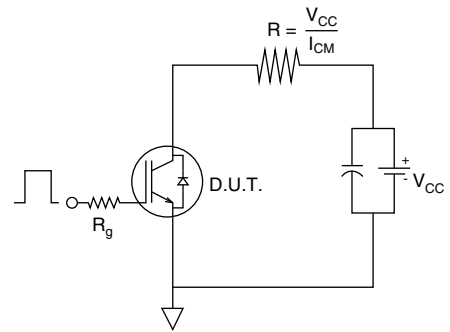

Fig. 19b - Pulsed Collector Current Test Circuit

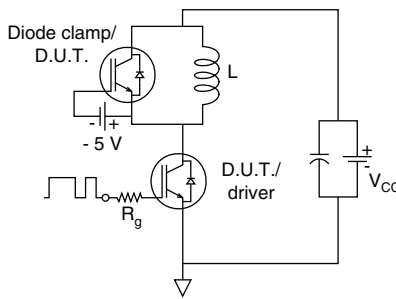

Fig. 20a - Switching Loss Test Circuit

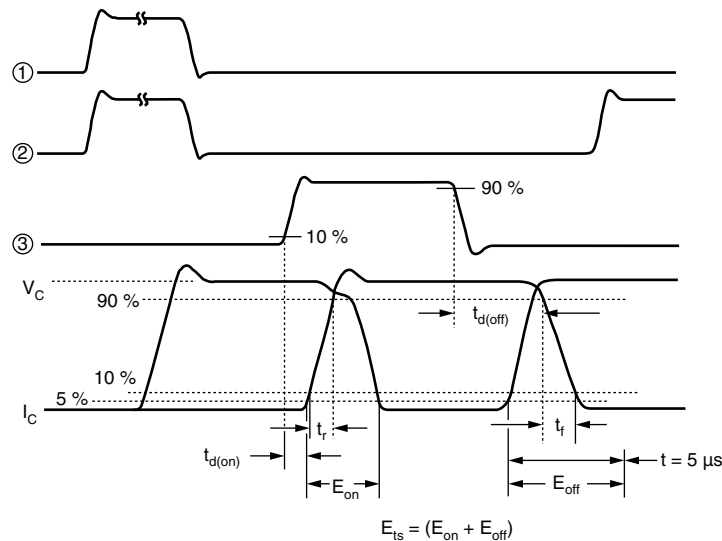

Fig. 20b - Switching Loss Waveforms Test Circuit

ORDERING INFORMATION TABLE

Device code	VS-	G	B	90	D	A	120	U
	①	②	③	④	⑤	⑥	⑦	⑧

- 1** - Vishay Semiconductors product
- 2** - Insulated Gate Bipolar Transistor (IGBT)
- 3** - B = IGBT Generation 5
- 4** - Current rating (90 = 90 A)
- 5** - Circuit configuration (D = Single switch with antiparallel diode)
- 6** - Package indicator (A = SOT-227)
- 7** - Voltage rating (120 = 1200 V)
- 8** - Speed/type (U = Ultrafast IGBT)

CIRCUIT CONFIGURATION		
CIRCUIT	CIRCUIT CONFIGURATION CODE	CIRCUIT DRAWING
Single switch with antiparallel diode	D	<div style="display: inline-block; vertical-align: top; margin-left: 20px;"> <p>Lead Assignment</p> </div>

LINKS TO RELATED DOCUMENTS	
Dimensions	www.vishay.com/doc?95423
Packaging information	www.vishay.com/doc?95425



SOT-227 Generation II

DIMENSIONS in millimeters (inches)

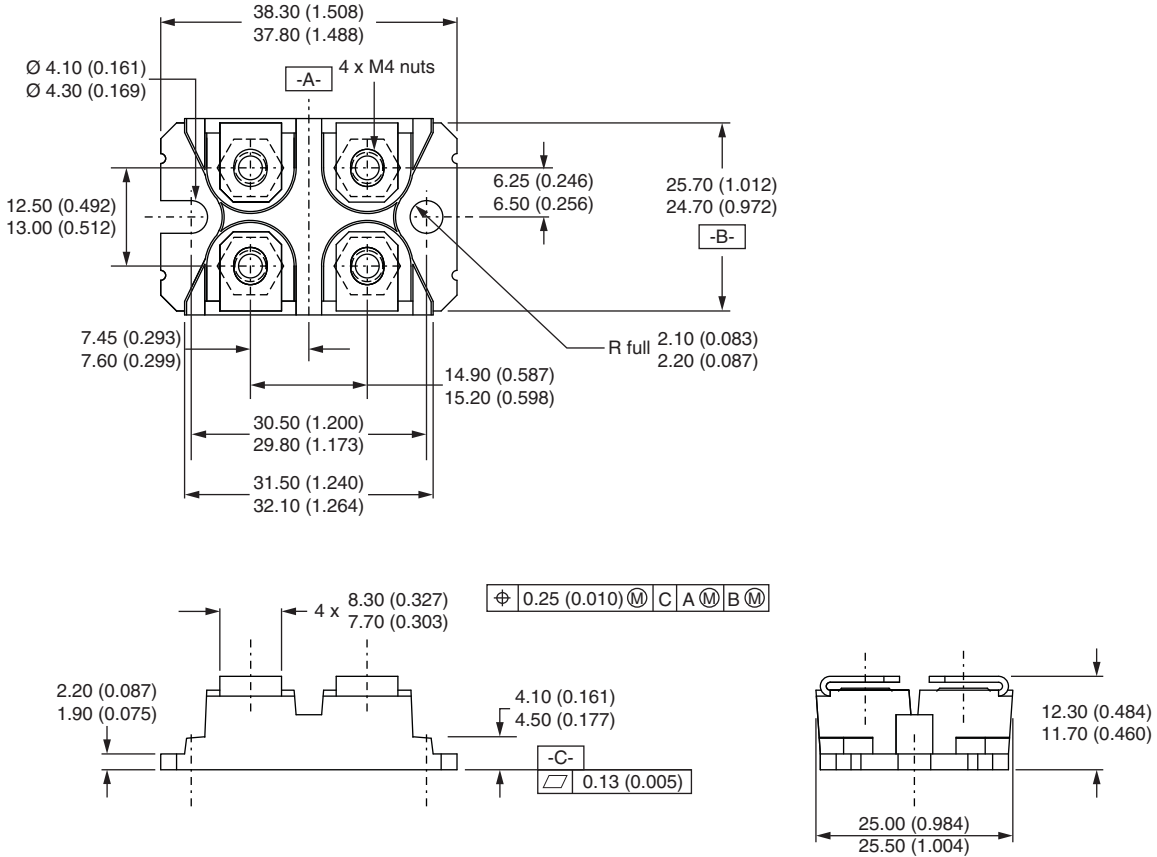

Note

- Controlling dimension: millimeter



Disclaimer

ALL PRODUCT, PRODUCT SPECIFICATIONS AND DATA ARE SUBJECT TO CHANGE WITHOUT NOTICE TO IMPROVE RELIABILITY, FUNCTION OR DESIGN OR OTHERWISE.

Vishay Intertechnology, Inc., its affiliates, agents, and employees, and all persons acting on its or their behalf (collectively, "Vishay"), disclaim any and all liability for any errors, inaccuracies or incompleteness contained in any datasheet or in any other disclosure relating to any product.

Vishay makes no warranty, representation or guarantee regarding the suitability of the products for any particular purpose or the continuing production of any product. To the maximum extent permitted by applicable law, Vishay disclaims (i) any and all liability arising out of the application or use of any product, (ii) any and all liability, including without limitation special, consequential or incidental damages, and (iii) any and all implied warranties, including warranties of fitness for particular purpose, non-infringement and merchantability.

Statements regarding the suitability of products for certain types of applications are based on Vishay's knowledge of typical requirements that are often placed on Vishay products in generic applications. Such statements are not binding statements about the suitability of products for a particular application. It is the customer's responsibility to validate that a particular product with the properties described in the product specification is suitable for use in a particular application. Parameters provided in datasheets and / or specifications may vary in different applications and performance may vary over time. All operating parameters, including typical parameters, must be validated for each customer application by the customer's technical experts. Product specifications do not expand or otherwise modify Vishay's terms and conditions of purchase, including but not limited to the warranty expressed therein.

Except as expressly indicated in writing, Vishay products are not designed for use in medical, life-saving, or life-sustaining applications or for any other application in which the failure of the Vishay product could result in personal injury or death. Customers using or selling Vishay products not expressly indicated for use in such applications do so at their own risk. Please contact authorized Vishay personnel to obtain written terms and conditions regarding products designed for such applications.

No license, express or implied, by estoppel or otherwise, to any intellectual property rights is granted by this document or by any conduct of Vishay. Product names and markings noted herein may be trademarks of their respective owners.