

ROHM Switching Regulator Solutions

Synchronous Buck Converter Controller

BD9611MUV-EVK-001

Description

Using a synchronous rectified step-down DC/DC converter IC BD9611MUV BD 9611MUV-EVK-001 evaluation board 15.0 V ~ output a 24 V input voltage 12.0 V. Provides 10.0A output current. Output current is possible with current settings by selecting high rated current FET and coil. You can adjust the loop characteristics by phase compensation components, can set the output voltage to change the IC external parts.

Evaluation Board Operating Limits and Absolute Maximum Ratings (This is not typical and the characteristics)

Unless otherwise specified : $V_{IN} = 24V$, $V_{OUT} = 12.0V$, $I_{out}=6A$

Parameter	Min	Typ	Max	Units	Conditions
Supply Voltage	15		36	V	
Output Voltage		12.0		V	RU1=120k Ω , RU2=20k Ω , RD1=10k Ω
Output Voltage range	1		$V_{IN} \times 0.8$	V	
Output Current	0		10	A	
Closed Loop Band Width		30.19		kHz	
Phase margin		130. 27		degrees	$I_{out}=8A$
Soft Start Time		8		ms	
Operating frequency		250		kHz	
Maximum Efficiency		95.1		%	$I_O = 4A$

Evaluation Board Operation Procedures

1. Connect power supply's GND terminal to GND on the evaluation board.
2. Connect power supply's VCC terminal to Vcc test point on the evaluation board. This will provide VCC to the IC U1. Please note that the VCC should be in range of 10V to 56V.
3. The output voltage can be measured at the test point V_{OUT}. Now turn on the load. The load can be increased up to 10A MAX.

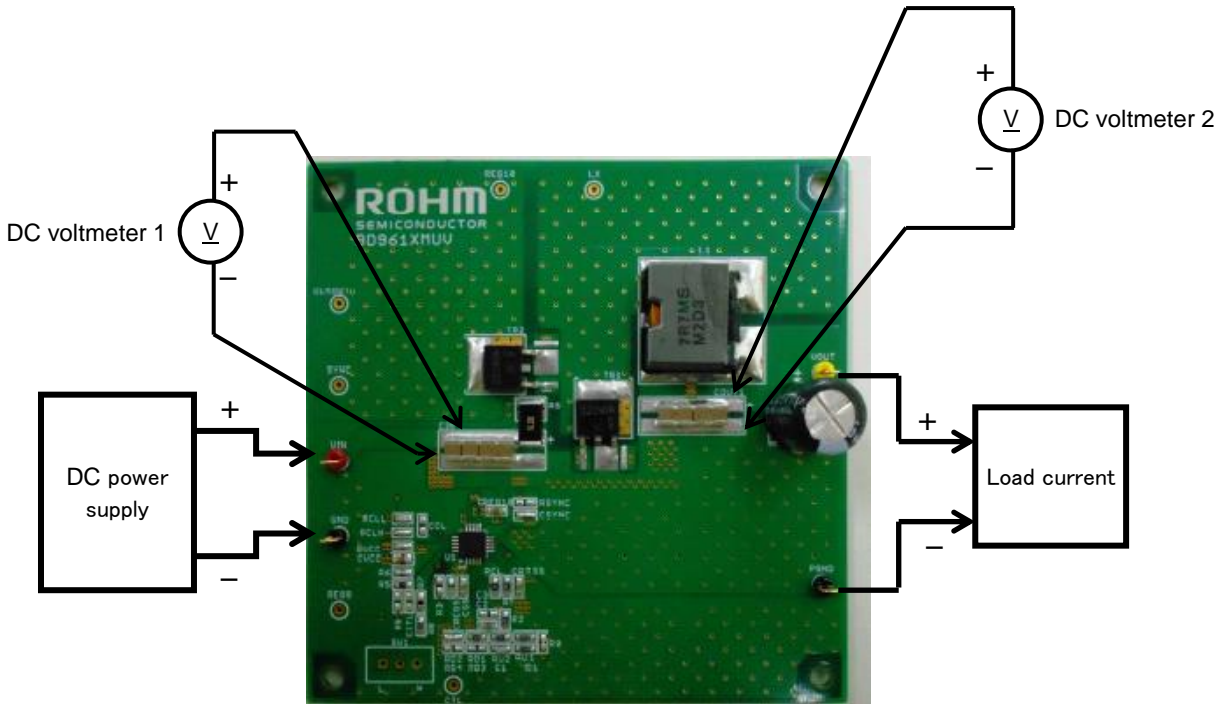

Figure 1. Evaluation board setup

Enable

You can switch between normal operation and standby mode to minimize power consumption by controlling the CTL of the IC (19 pin). Open to short and SW1 R9, as VIN pin resistance partial pressure using R5, R6, R7, R8, switch SW1 on the off side and in standby mode. Short between the middle and ON-side.

You can also by CTL pin and GND terminals of voltage to control and eliminate the R9 standby mode or normal behavior. CTL Terminal voltage is 2.6 V or less in standby mode: 2.6 V or more usually works. If CTL terminals directly controlling voltage hysteresis voltage at low current internal and external resistance is set so the hysteresis voltage voltage supplying CTL terminal by the impedance of the power supply and internal constant current.

Application circuit (V_{out}=12.0)

V_{IN} = 15.0V~30V, V_{OUT} = 12.0V

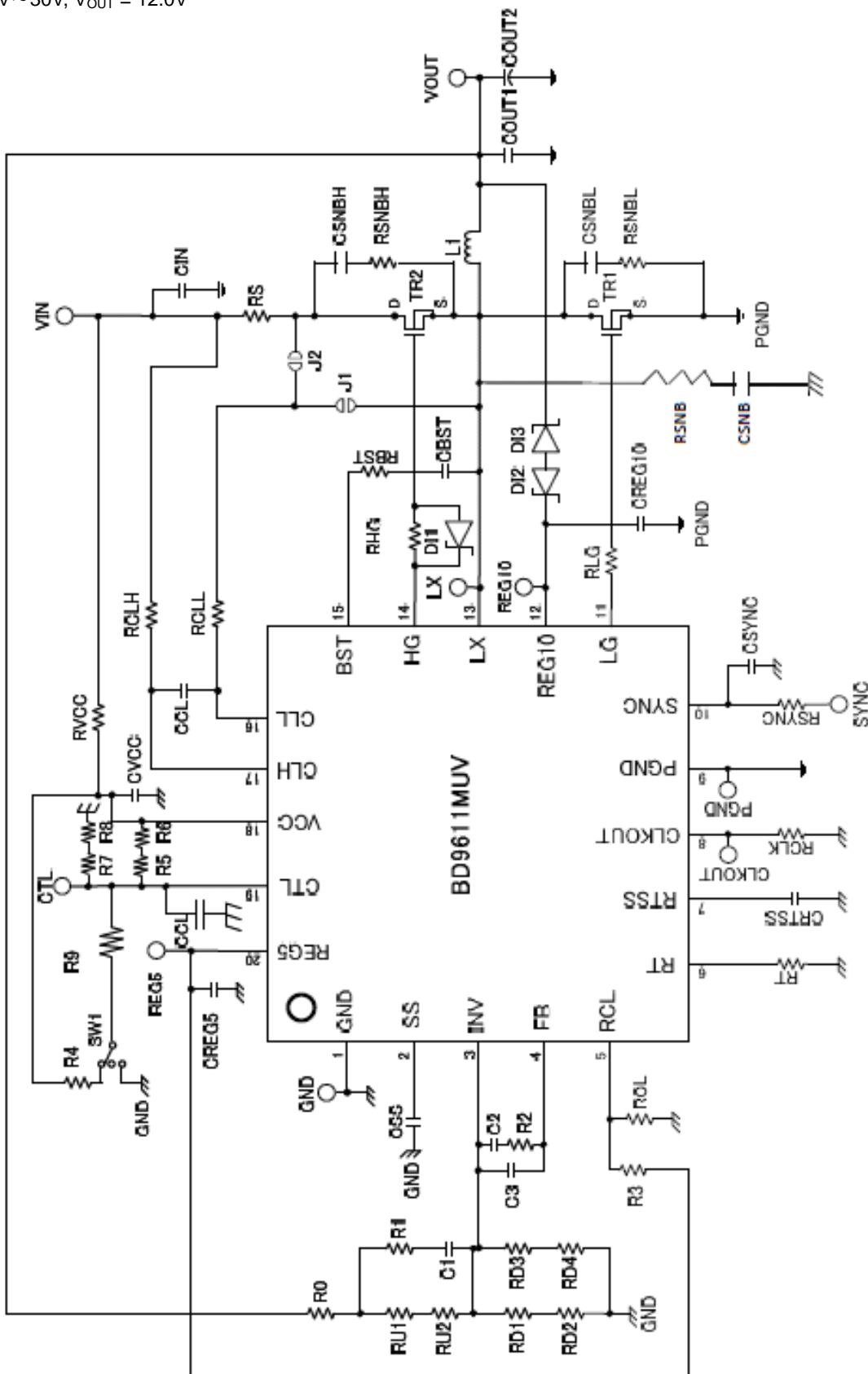

Figure 2. BD9611MUV-EVK-001 Application circuit

Evaluation Board BOM (Vout =12.0V)

Item	Qty	Reference designator	Description	Manufacture	Parts number
1	1	U1	BD9611MUV	ROHM	BD9611MUV
2	1	R1	RES 1K OHM 1/10W 1% 0603 SMD	ROHM	MCR03EZPFX1001
3	1	R2	RES 15K OHM 1/10W 1% 0603 SMD	ROHM	MCR03EZPFX1502
4	1	R5	RES 27K OHM 1/10W 1% 0603 SMD	ROHM	MCR03EZPFX2702
5	1	R7	RES 5.1K OHM 1/10W 1% 0603 SMD	ROHM	MCR03EZPFX5101
6	1	R8	RES 430 OHM 1/10W 1% 0603 SMD	ROHM	MCR03EZPFX4300
7	1	RU1	RES 120K OHM 1/10W 1% 0603 SMD	ROHM	MCR03EZPFX1203
8	2	RU2, RCL	RES 20K OHM 1/10W 1% 0603 SMD	ROHM	MCR03EZPFX2002
9	1	RD1	RES 10K OHM 1/10W 1% 0603 SMD	ROHM	MCR03EZPFX1002
10	1	RT	RES 75K OHM 1/10W 1% 0603 SMD	ROHM	MCR03EZPD7502
11	1	RHG	RES 10 OHM 1/10W 1% 0603 SMD	ROHM	MCR03EZPFX10R0
12	2	DI1, DI2	RB161VA-20	ROHM	RB161VA-20
13	1	RS	RES 5m OHM 2W 1% 6432 SMD	ROHM	PMR100HZPFU5L00
14	1	C1	CAP CER 180PF 50V 5% NPO 0603	MURATA	GRM1885C1H181JA01D
15	1	C2	CAP CER 2200PF 50V 10% X7R 0603	MURATA	GRM188R71H333KA01D
16	2	CSS, CRTSS	CAP CER 10000PF 16V 10% X7R 0603	MURATA	GRM188R71C103KA01D
17	1	CREG10	CAP CER 1UF 16V 10% X7R 0603	MURATA	GRM188R71C105KA01D
18	1	CBST	CAP CER 0.47UF 25V 10% X7R 0603	MURATA	GRM188R71E474KA12D
19	4	CIN	CAP CER 10UF 50V 10% X7R 3225	MURATA	GRM32ER71H106KA12L
20	1	COUT1	CAP ALUM 220UF 50V 20% RADIAL	nichicon	UVR1H221MPD1TD
21	4	COUT2	CAP CER 10UF 50V 10% X7R 3225	MURATA	GRM32ER71H106KA12L
22	1	CVCC	CAP CER 1UF 50V 10% X7R 2125	MURATA	GRM21BB31H105KA12L
23	1	CREG5	CAP CER 0.1UF 25V 10% X5R 0402	MURATA	GRM155R61E104KA87D
24	2	Tr1, Tr2	Nch-FET 60V 22A 20W 26mOHM	ROHM	RSD221N06TL
25	1	L1	INDUCTOR POWER 7.7UH 10A SMD	Sumida	CDEP147NP-7R7MC-95
26	11	R0, R6, RD2, RLG, RBST, RCLH, RCLL, RVCC, CSYNC, J2, DI3	short	-	-
27	10	R3, R4, R9, RD3, RD4, C3 RCLK, RSYNC, CCL, J1	open	-	-

About the LX pin overshoot voltage measures snubber circuit

To LX pin voltage overshoot voltage by the parasitic inductance of the parasitic capacitance of the high-side and low-side FET and board layout pattern occurs. You need to use power supply voltage range and load range, and output short circuit during the LX pin voltage does not exceed the recommended operating range.

Snubber circuits described in Figure 2 overshoot LX pin voltage is greater if the LX pin and PGND between RSNB resistor and capacitor CSNB connected in series and set the to overshoot.

※CSNB is RSNB evaluation board pattern. We recommend placing the pattern during the overshoot occurs in the set assessment measures allow.

< matters to be attended to >

This article is not what 1 example of application BD9611MUV circuits and the operation.

Curve data

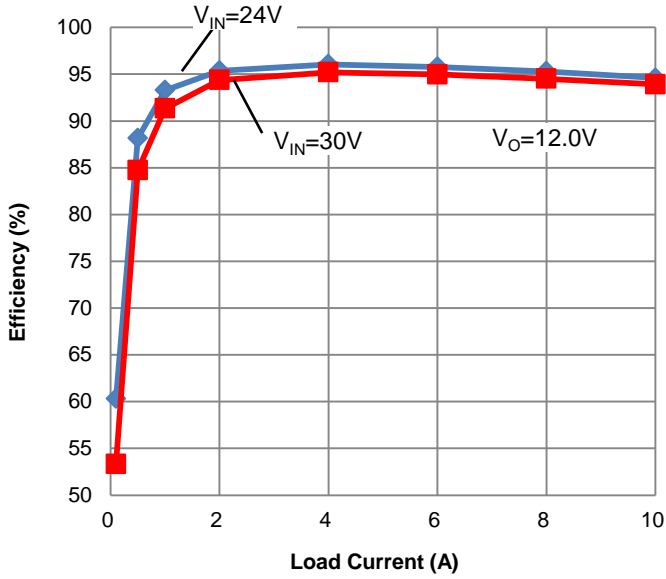

Figure 9. Efficiency-Load Current

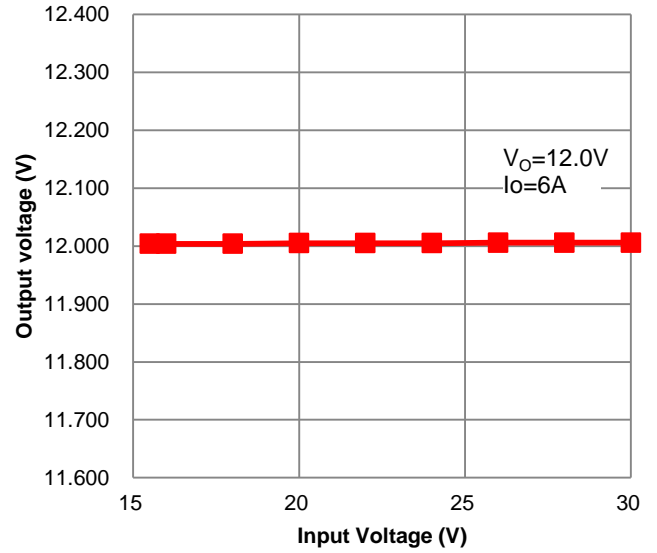

Figure 10. Line regulation

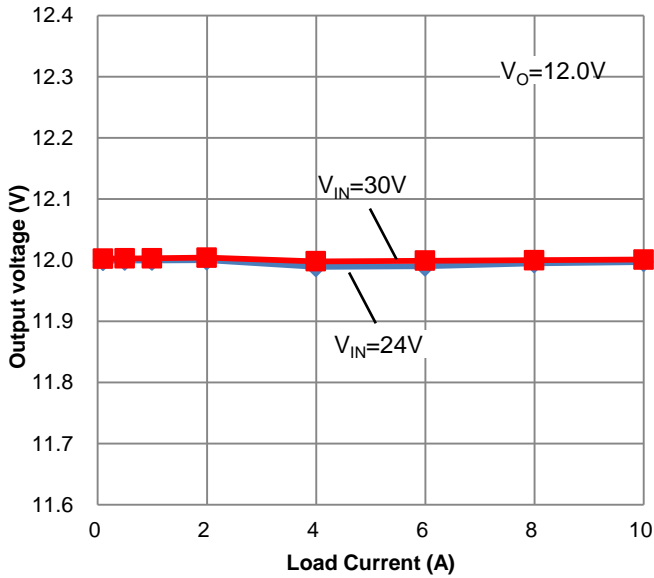

Figure 11. Load regulation

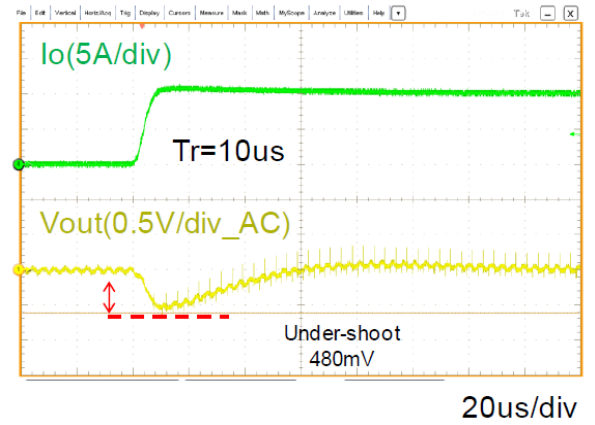

Figure 12. Load Response Characteristics
0A→10A

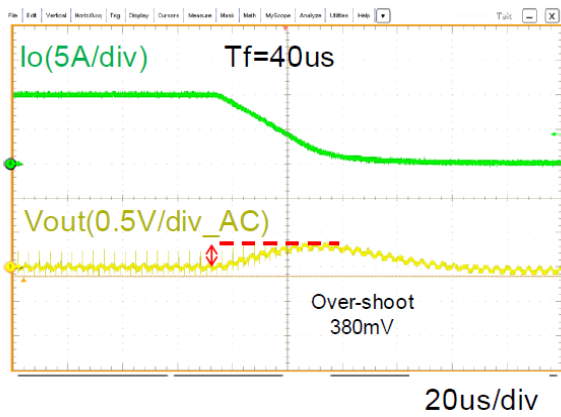

Figure 13. Load Response Characteristics
10A→0A

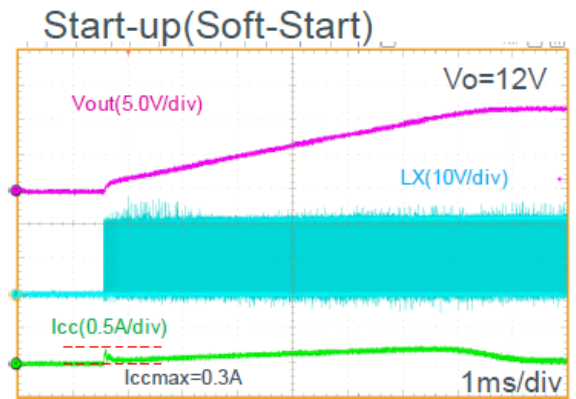

Figure 14. Start-up waves (Soft start)

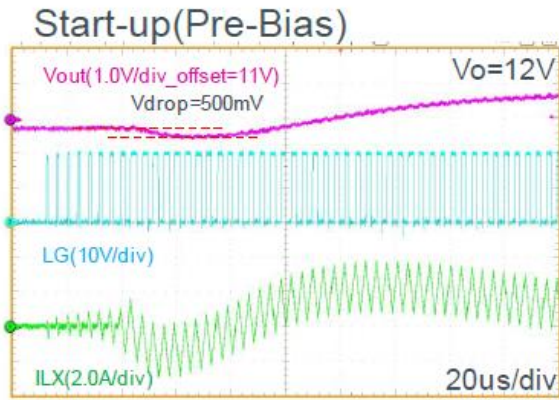

Figure 15. Start-up waves (Pre-bias)

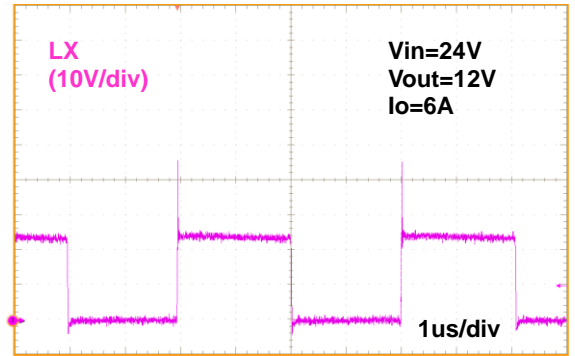

Figure 16. LX terminal waves

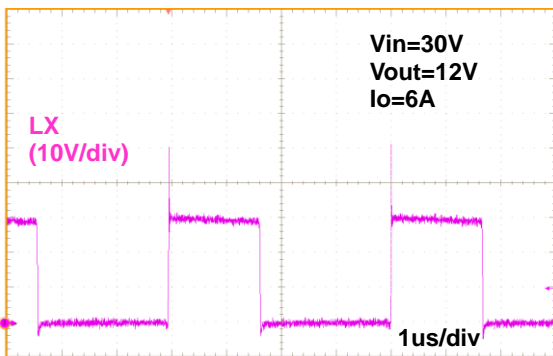

Figure 17. LX terminal waves

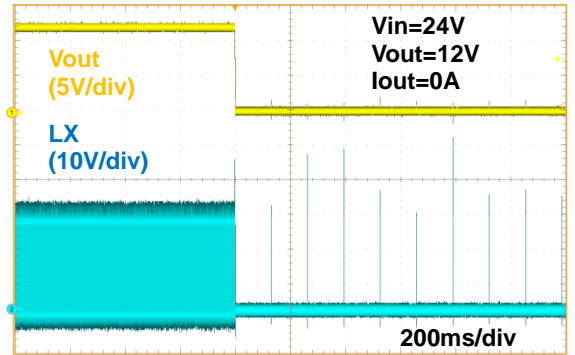

Figure 18. Output short waves

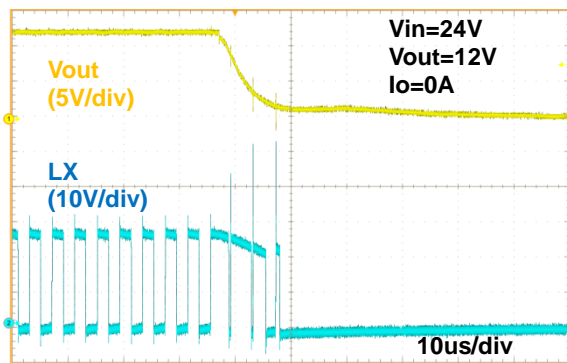

Figure 19. Output shorted waves(Extend)

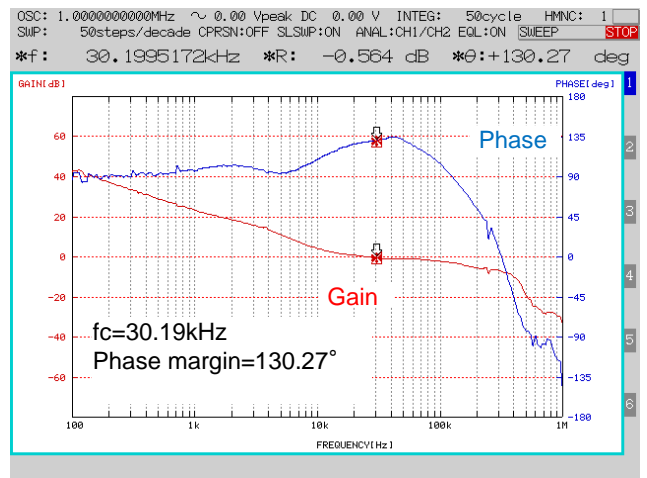

Figure 20. Frequency Response $V_{IN} = 24V$, $V_O = 12.0V$, $I_O = 8A$

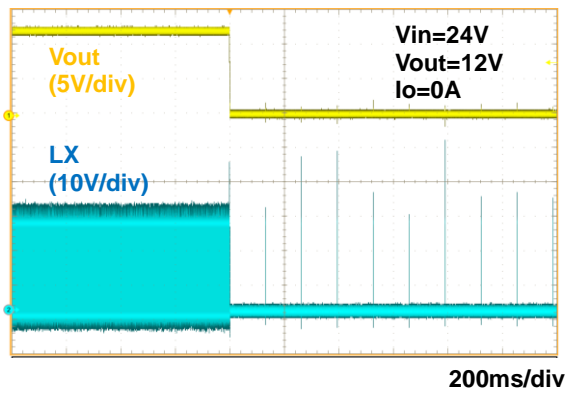

Figure 21. OCP Detect waves

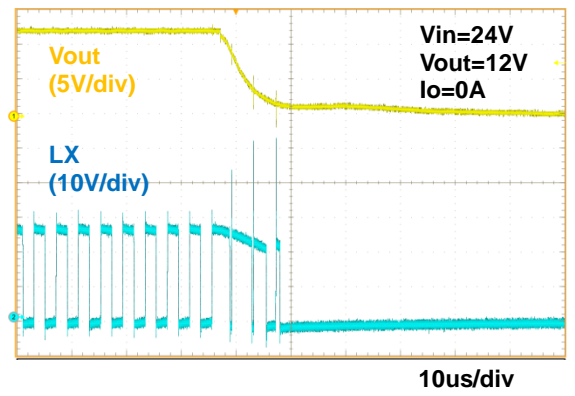

Figure 22. OCP Detect waves (Extend)

Layout pattern

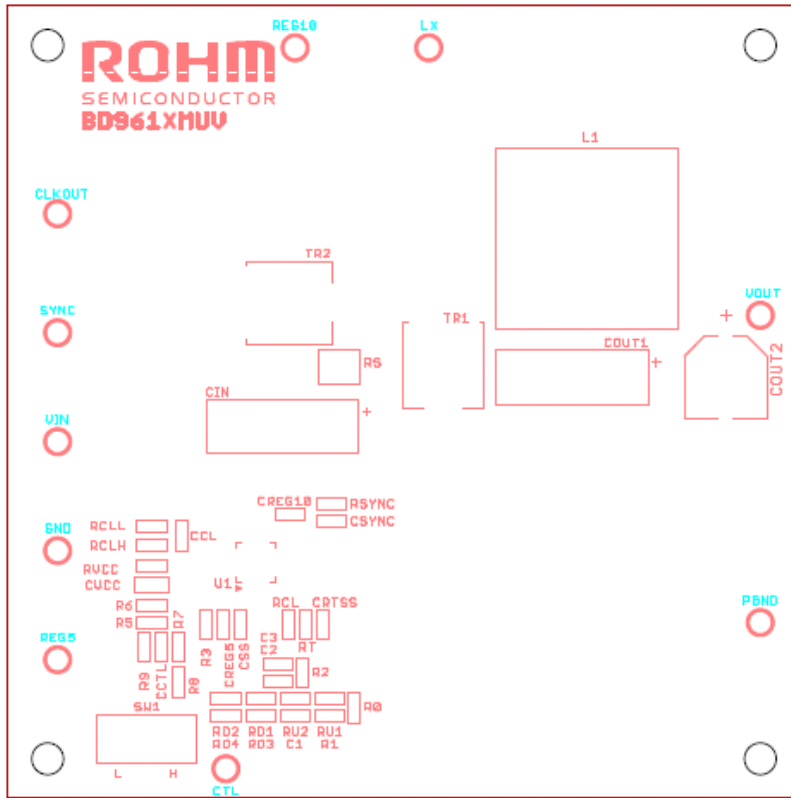

Figure 3. Top Silkscreen (Top view)

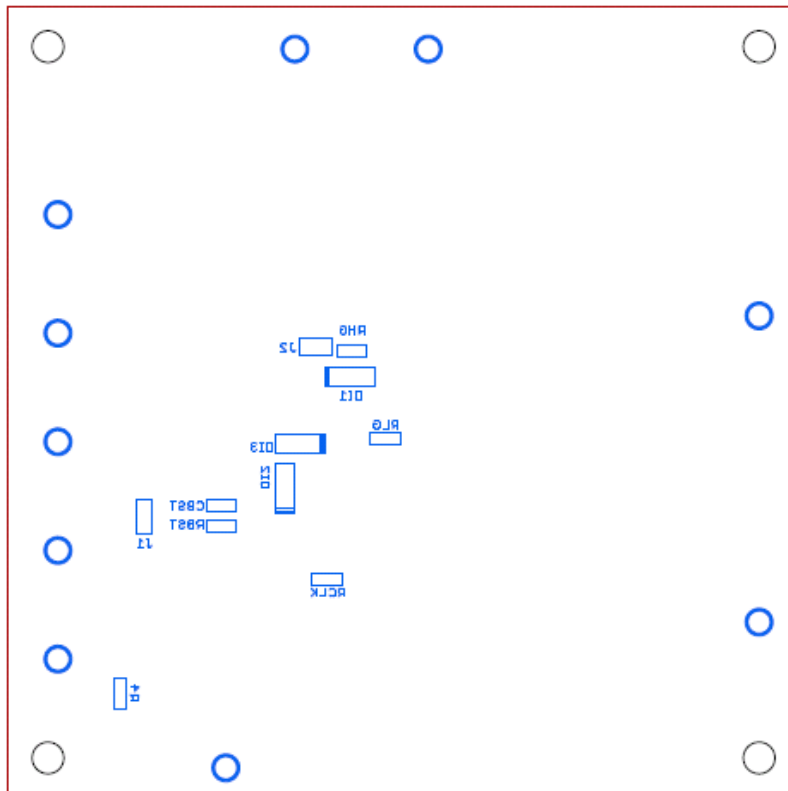

Figure 4. Bottom Silkscreen (Bottom view)

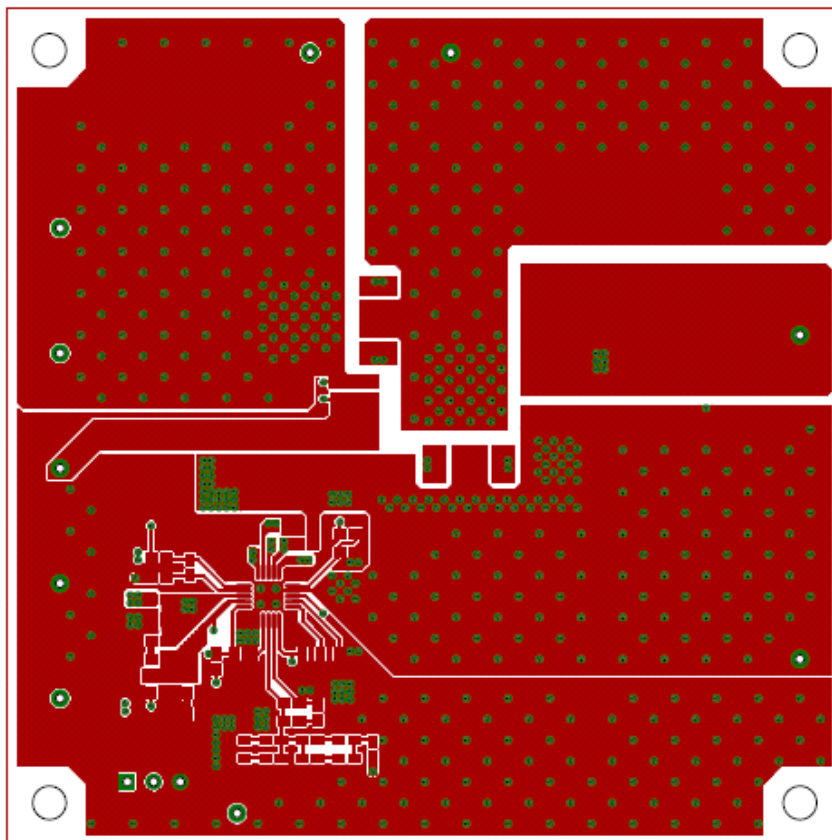

Figure 5. Top Layer (Top view)

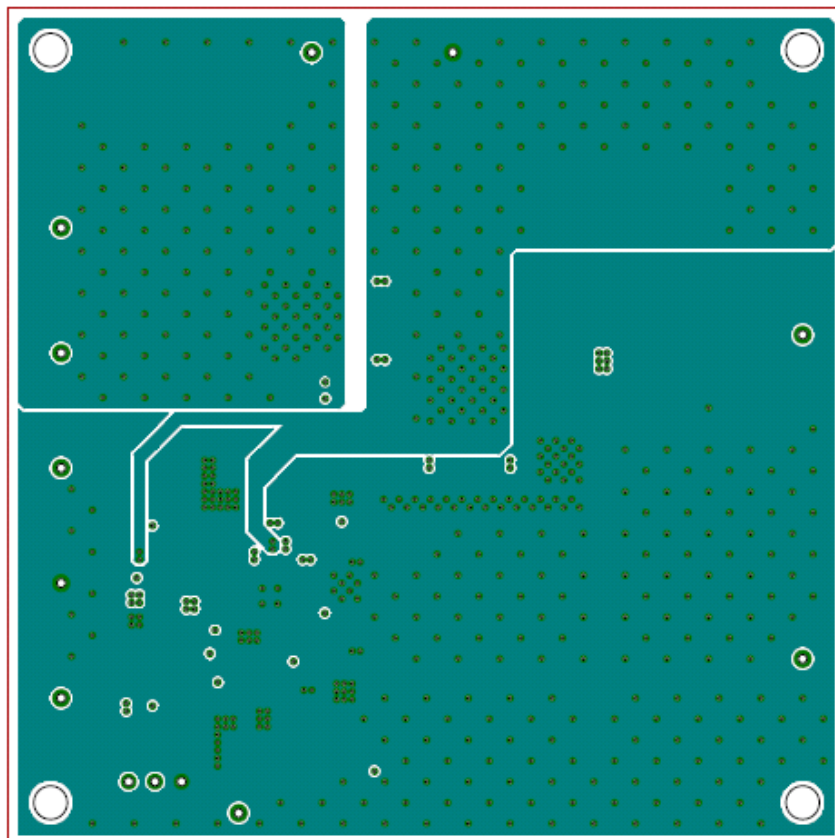

Figure 6. L2 Layer (Middle view)

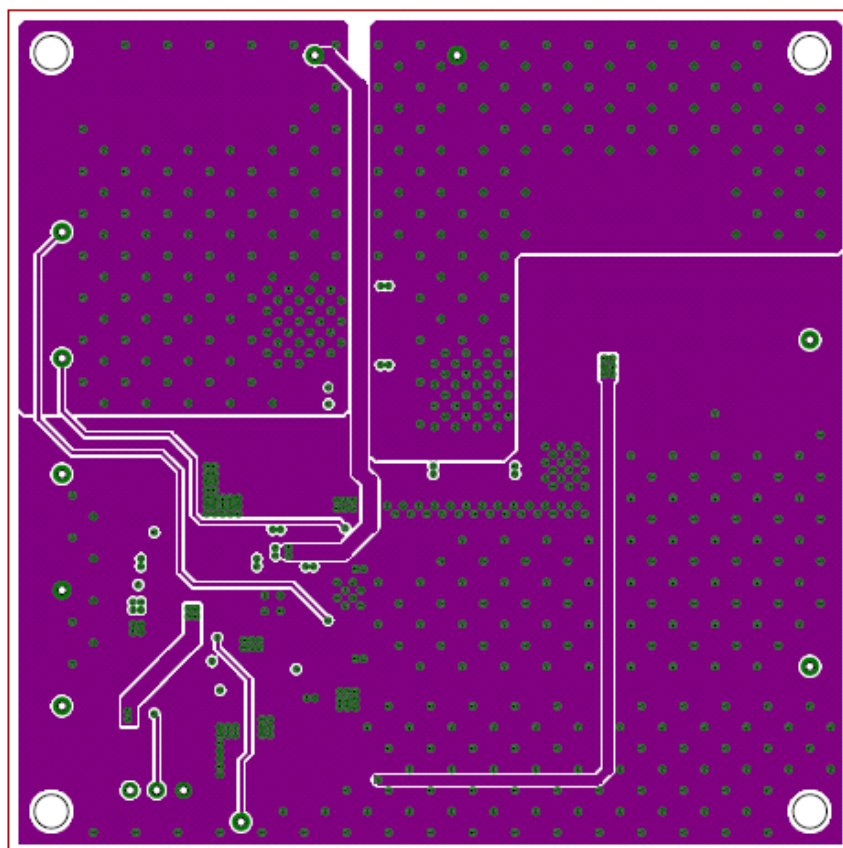

Figure 7. L3 Layer (Middle view)

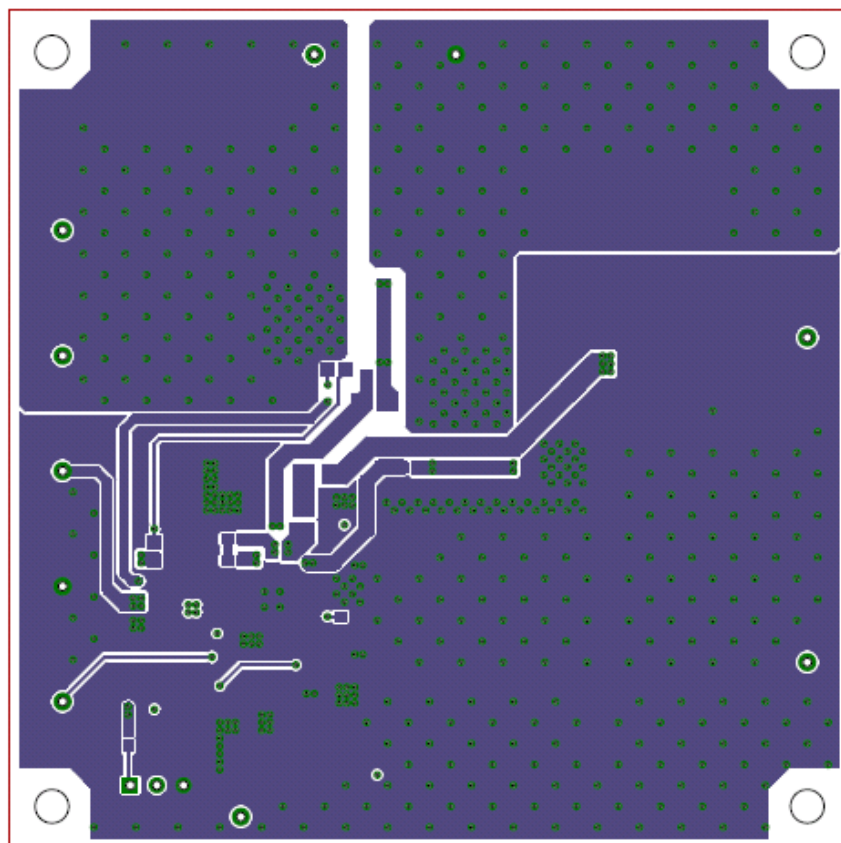

Figure 8. Bottom Layer (Bottom view)

Notes

- 1) The information contained herein is subject to change without notice.
- 2) Before you use our Products, please contact our sales representative and verify the latest specifications :
- 3) Although ROHM is continuously working to improve product reliability and quality, semiconductors can break down and malfunction due to various factors.
Therefore, in order to prevent personal injury or fire arising from failure, please take safety measures such as complying with the derating characteristics, implementing redundant and fire prevention designs, and utilizing backups and fail-safe procedures. ROHM shall have no responsibility for any damages arising out of the use of our Products beyond the rating specified by ROHM.
- 4) Examples of application circuits, circuit constants and any other information contained herein are provided only to illustrate the standard usage and operations of the Products. The peripheral conditions must be taken into account when designing circuits for mass production.
- 5) The technical information specified herein is intended only to show the typical functions of and examples of application circuits for the Products. ROHM does not grant you, explicitly or implicitly, any license to use or exercise intellectual property or other rights held by ROHM or any other parties. ROHM shall have no responsibility whatsoever for any dispute arising out of the use of such technical information.
- 6) The Products are intended for use in general electronic equipment (i.e. AV/OA devices, communication, consumer systems, gaming/entertainment sets) as well as the applications indicated in this document.
- 7) The Products specified in this document are not designed to be radiation tolerant.
- 8) For use of our Products in applications requiring a high degree of reliability (as exemplified below), please contact and consult with a ROHM representative : transportation equipment (i.e. cars, ships, trains), primary communication equipment, traffic lights, fire/crime prevention, safety equipment, medical systems, servers, solar cells, and power transmission systems.
- 9) Do not use our Products in applications requiring extremely high reliability, such as aerospace equipment, nuclear power control systems, and submarine repeaters.
- 10) ROHM shall have no responsibility for any damages or injury arising from non-compliance with the recommended usage conditions and specifications contained herein.
- 11) ROHM has used reasonable care to ensure the accuracy of the information contained in this document. However, ROHM does not warrant that such information is error-free, and ROHM shall have no responsibility for any damages arising from any inaccuracy or misprint of such information.
- 12) Please use the Products in accordance with any applicable environmental laws and regulations, such as the RoHS Directive. For more details, including RoHS compatibility, please contact a ROHM sales office. ROHM shall have no responsibility for any damages or losses resulting from non-compliance with any applicable laws or regulations.
- 13) When providing our Products and technologies contained in this document to other countries, you must abide by the procedures and provisions stipulated in all applicable export laws and regulations, including without limitation the US Export Administration Regulations and the Foreign Exchange and Foreign Trade Act.
- 14) This document, in part or in whole, may not be reprinted or reproduced without prior consent of ROHM.



Thank you for your accessing to ROHM product informations.
More detail product informations and catalogs are available, please contact us.

ROHM Customer Support System

<http://www.rohm.com/contact/>